

# Technical Data Table | R290 Monobloc Hydro Unit

## Technical specification

Efficiency data		Range	9 kW (3 Ø)	12 kW (1 Ø) / 12 kW (3 Ø)	14 kW (1 Ø) / 14 kW (3 Ø)	16 kW (1 Ø) / 16 kW (3 Ø)
Seasonal space heating eff. class (35°C / 55°C)		-	A+++ / A++	A+++ / A+++	A+++ / A+++	A+++ / A+++
Seasonal space heating efficiency ( $\eta_{sp}$ ) (35°C / 55°C)		%	206 / 147	215 / 156	212 / 155	201 / 154
SCOP (35°C / 55°C)		-	5.23 / 3.75	5.45 / 3.97	5.38 / 3.96	5.11 / 3.92
Sound power level (outdoor unit)	Rated / low noise mode	dB(A)	49 / 48	49 / 48	51 / 50	52 / 51
Sound pressure level at 5 m <sup>1</sup> (outdoor unit)	Rated / low noise mode	dB(A)	27 / 26	27 / 26	29 / 28	30 / 29
Sound power level (indoor unit)	Rated	dB(A)	39			
Sound pressure level at 1 m <sup>1</sup> (indoor unit)	Rated	dB(A)	31			

Nominal capacity and COP / EER						
Air +7°C / water +35°C	Heating capacity / COP	kW / -	9.00 / 4.90	12.00 / 4.70	14.00 / 4.50	16.00 / 4.30
Air +2°C / water +35°C	Heating capacity / COP	kW / -	9.00 / 3.88	12.00 / 3.72	14.00 / 3.61	14.50 / 3.49
Air -7°C / water +35°C	Heating capacity / COP	kW / -	8.90 / 3.44	11.80 / 3.27	13.00 / 3.21	13.80 / 3.17
Air +7°C / water +55°C	Heating capacity / COP	kW / -	9.00 / 3.20	10.00 / 3.10	11.00 / 3.25	12.00 / 3.30
Air -7°C / water +55°C	Heating capacity / COP	kW / -	7.00 / 2.43	9.30 / 2.32	10.30 / 2.28	10.90 / 2.26
Air +35°C / water +18°C	Cooling capacity / EER	kW / -	9.00 / 3.90	11.50 / 3.78	12.00 / 3.70	12.50 / 3.70
Air +35°C / water +7°C	Cooling capacity / EER	kW / -	9.00 / 3.24	10.50 / 3.12	12.00 / 2.99	12.50 / 2.95

Outdoor unit		Unit	HM093HFX UB60	HM121HF UB60 HM123HF UB60	HM141HF UB60 HM143HF UB60	HM161HF UB60 HM163HF UB60
Operation range (outdoor air temperature)	Heating & DHW (Min. - Max.)	°C	-28 ~ 35			
	Cooling (Min. - Max.)	°C	5 ~ 48			
Refrigerant	Type	-	R290			
	GWP	-	3			
	Precharged amount	g	1,200			
	t-CO <sub>2</sub> eq.	-	0.0036			
Piping connections (water)	Inlet / outlet diameter	inch	Male PT 1" according to ISO 7-1 (tapered pipe threads)			
Dimension	W x H x D	mm	1,560 x 1,019 x 520			
Weight	Empty	kg	181.0			
Exterior	Color of chassis / RAL code	-	Dawn gray / RAL 7037			
	Color of front grille / RAL code	-	Dark dawn gray / RAL 7012			
Power supply	Voltage, phase, frequency	V, Ø, Hz	380 ~ 415, 3, 50		220 ~ 240, 1, 50 / 380 ~ 415, 3, 50	
	Recommended circuit breaker	A	3 Ø: 16		1 Ø: 25 / 3 Ø: 16	

Indoor unit		Unit	HN1616HC NK0 / HN1639HC NK0			
Operation range (leaving water temperature)	Heating (Min. - Max.)	°C	15 ~ 75			
	Cooling (Min. - Max.)	°C	5 ~ 27			
	DHW (Min. - Max.)	°C	15 ~ 80 <sup>2)</sup>			
Backup heater	Capacity combination	kW	3.0 + 3.0 / 3.0 + 3.0 + 3.0			
	Power supply	V, Ø, Hz	220 ~ 240, 1, 50 / 380 ~ 415, 3, 50			
	Rated running current	A	26 / 13			
Piping connections (water)	Heating circuit outlet pipe	inch	Male PT 1" according to ISO 7-1 (tapered pipe threads)			
	Heating circuit inlet pipe	inch				
	Outlet pipe to outdoor unit	inch				
	Inlet pipe from outdoor unit	inch				
Dimension	W x H x D	mm	490 x 850 x 315			
Weight	Empty	kg	1 Ø: 30.0 / 3 Ø: 31.0			
Exterior	Color / RAL code	-	Noble white / RAL 9016			
Power supply	Voltage, phase, frequency	V, Ø, Hz	220 ~ 240, 1, 50			
	Recommended circuit breaker	A	10			

Indoor unit		Unit	PHCS0			
Operation range (leaving water temperature)	Heating (Min. - Max.)	°C	15 ~ 75			
	Cooling (Min. - Max.)	°C	5 ~ 27			
	DHW (Min. - Max.)	°C	15 ~ 80 <sup>2)</sup>			
Dimension	W x H x D	mm	420 x 490 x 141			
Weight	Net	kg	6.7			
Exterior	Color / RAL code	-	Essence White / RAL 9003			
Power supply	Voltage, phase, frequency	V, Ø, Hz	220 ~ 240, 1, 50			
	Recommended circuit breaker	A	10			

1) Sound power level is measured in accordance with EN 12102-1 and ISO 9614. Sound pressure level is converted from sound power level based on a tonality penalty of 0 dB and installation in free-field. The directivity index (Q) is assumed as 2.

2) DHW 65 ~ 80°C operating is available only when the booster heater is operating.

A heat pump for a sustainable future

# THERMA V™ R290 Monobloc

- Reliable
- Future-proof
- Eco-responsible



Browse now

※ R290: Natural refrigerant with Global Warming Potential (GWP) = 3



www.lg.com http://partner.lge.com

Copyright © 2024 LG Electronics. All rights reserved.



# THERMA V™ R290 Monobloc

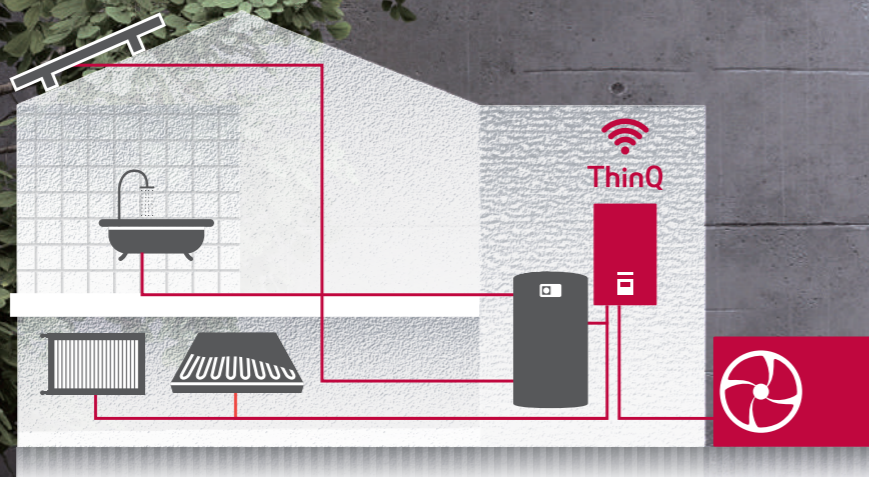

## Key Features

- Capacity range with 4 sizes from 9 to 16 kW for renovation and large new builds
- Natural refrigerant R290 with low GWP (3)
- Refined gray design that adapts to various surroundings
- One of the quietest models on the market (49 dB(A) for 12 kW models)
- Maximum flow temperature up to 75°C
- Operation range down to -28°C

R290 75°C A+++ ThinQ

※ R290 : Natural refrigerant with GWP 3

## Product Range

Product	Phase	Capacity (kW)	Indoor Unit		Outdoor Unit
R290  Monobloc	1 Ø	12		PHCS0	HM121HF UB60
		14			HM141HF UB60
		16			HM161HF UB60
	3 Ø	9		PHCS0	HM093HFX UB60
		12			HM123HF UB60
		14			HM143HF UB60
		16			HM163HF UB60
					HN1639HC NK0

※ The installation scene used in this leaflet is intended to visualize the product and installation manuals and local regulations must be observed.

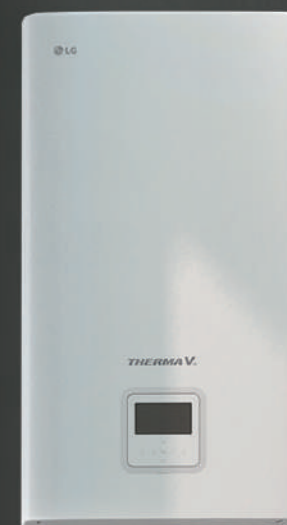

## New Design

European design



- Refined gray design with wavy grille

## High reliability



Anti-icing and Deicing technologies for R290 Monobloc

- ❶ Defrost operation by dual EEVs & Cycle
- ❷ Corrugated fin
- ❸ Base pan heating (heater)
- ❹ Elimination of side panel and rear grille
- ❺ Frost-free for bottom pass of heat exchanger
- ❻ Increased quantity for drain hole

## High Efficiency Operation

Exceptional efficiency



## Annual energy cost simulation

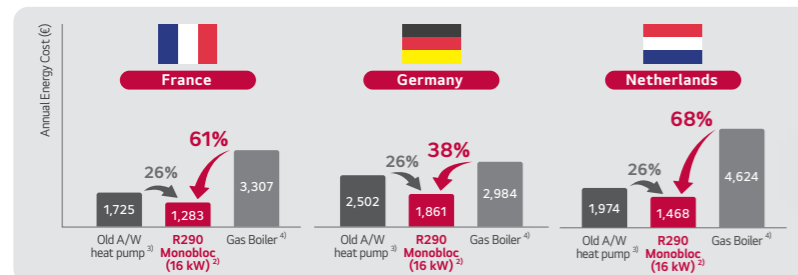

\* This simulation result may differ from actual values due to assumptions.

\* Annual energy costs are calculated based on national gas and electricity prices as of June 2023 and may differ from the actual cost paid by customers depending on energy price changes and individual energy use patterns. For conventional heat pumps and gas boilers, energy consumption matches LG Therma V R290 Monobloc 16 kW's heating demand. Specific assumptions include:

- 1) considered only space heating for all system (DHW operation is not considered)
- 2) average climate, low temperature application (35°C)
- 3) SCOP 2.7 to account for a 10-year-old heat pump's performance degradation.
- 4) 90% efficiency with a condensing boiler.

## Extremely Quiet Operation

Heats home in hushed tones

	9 kW & 12 kW	14 kW	16 kW
<b>QUIET MARK</b>			
Sound power level <sup>1)</sup> (heating / rated)	49	51	52
Sound power level <sup>1)</sup> (heating / low noise mode)	48	50	51

<sup>1)</sup> Sound power level is measured in accordance with EN 12102-1 and ISO 9614.

Ensuring regulatory compliance across all EU markets

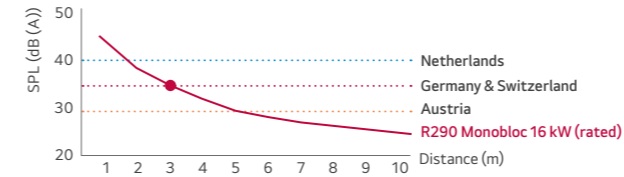

Customers can have peace of mind with no risk of complaints and no additional costs for acoustic enclosures.

## Improved Operational Stability

Freezing outside, but toasty inside



The R290 Monobloc can function in external temperatures as low as -28°C. Plus, customers can retain their existing radiators as the system can generate a water flow of up to 75°C, offering a cost-saving advantage.

## Freedom of Integration

Customized combinations to meet diverse needs

Since Therma V R290 Monobloc has hydro components integrated into the outdoor unit, it can be combined with various indoor units to implement applications tailored to customer needs.

Outdoor unit	Indoor unit type
	<b>Control Unit</b> <ul style="list-style-type: none"> <li>• Stand-alone concept</li> <li>• Easy integration with 3<sup>rd</sup> party equipment</li> </ul>
	<b>Hydro Unit</b> <ul style="list-style-type: none"> <li>• Back-up heater &amp; expansion tank integrated inside the Hydro Unit</li> </ul>
	<b>To be released</b>
	<b>Combi Unit*</b> <ul style="list-style-type: none"> <li>• DHW tank, electric heater, expansion tank integrated inside the Combi Unit</li> <li>• 200 l stainless steel tank</li> </ul>

\* The Combi Unit are under development, that will be launched in 3Q 2024.

## Convenience

Easy installation

The two-way piping connection method not only grants greater installation flexibility but also offers distinct advantages when it comes to concealing underground piping for both aesthetic and frost protection purposes.

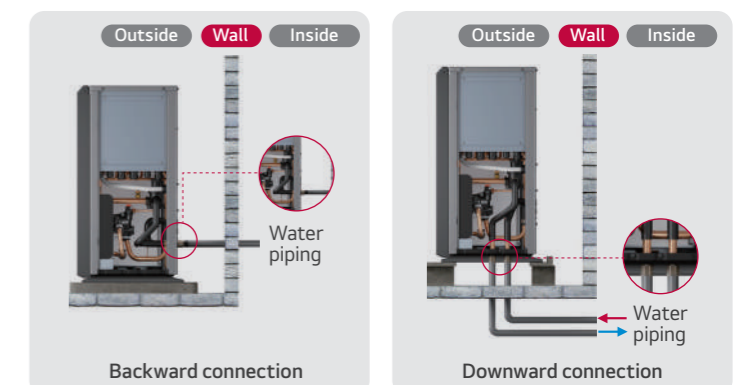

# Why choose

# Therma V™

# R290 Monobloc



※ R290: Natural refrigerant with GWP 3

## LG Smart Home Energy Package

### Powering homes the smart way and saving energy bills

With LG, you are able to minimize the energy cost and one step closer to the ultimate smart home.

\* Availability of LG Smart Home Energy Package may vary by region.

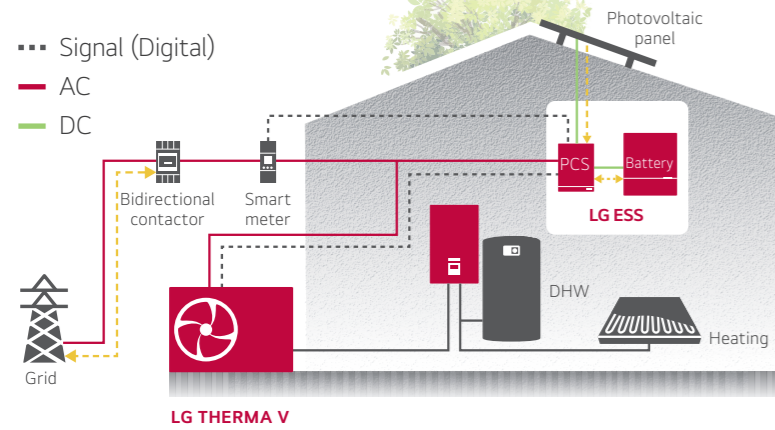

## Accessories for R290 Monobloc

Item	Model name
Outdoor air temp. sensor	PHATS0
Water tank sensor	PHRSTA0
Room temperature sensor	PQRSTA0
Thermistor for 2nd circuit or e/heater	PRSTAT5K10
DHW tank kit	PHLTA
Drain pan	PHDPC
Cover plate	PDC-HK10
Wi-Fi modem	PWFMD200
Cloud gateway	PWFMD200

## Interior & Connections

### Outdoor Unit

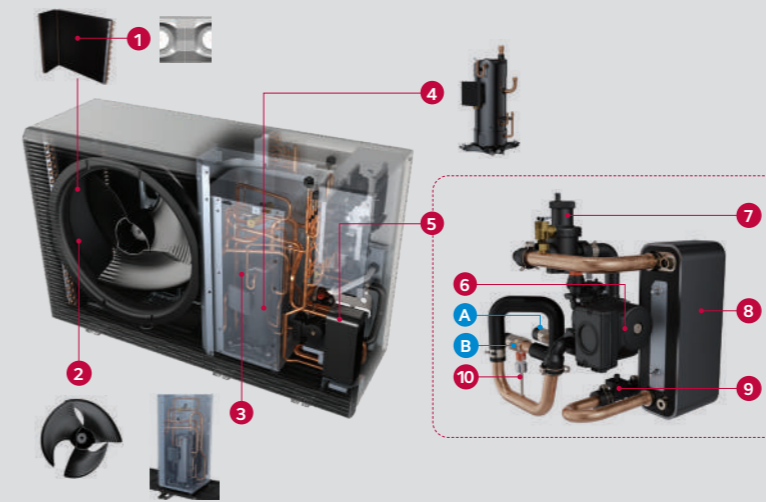

### Components

- 1 Black Fin heat exchanger (air / ref.)
- 2 New biomimetic fan
- 3 Dual sound shield
- 4 R290 scroll compressor
- 5 Hydronic components assembly
- 6 Water pump
- 7 Deaerator
- 8 Plate heat exchanger (ref / water)
- 9 Flow sensor
- 10 Pressure sensor

### Connections

- A Leaving water pipe (male PT 1")
- B Entering water pipe (male PT 1")

### Indoor Unit

Hydro Unit

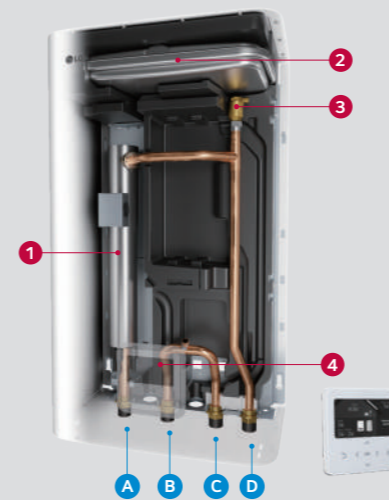

Control Unit



### Components

- 1 Backup heater (1 Ø: 6 kW / 3 Ø: 9 kW)
- 2 Expansion tank (8 l)
- 3 Air vent valve
- 4 Standard III remote controller

### Connections

- A Heating circuit outlet pipe (male PT 1")
- B Heating circuit inlet pipe (male PT 1")
- C Outlet pipe to outdoor unit (male PT 1")
- D Inlet pipe from outdoor unit (male PT 1")

## Tools & Services

For all customers including designers, installers, and end users.



### LATS THERMA V

A web based simulation tool that enables to choose optimized THERMA V model from various capacity range and simulates its energy cost comparing to other heating solutions.

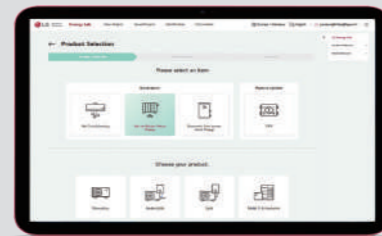

### LATS Energy Lab

LG Energy Lab online is a web version tool that can print energy labels. It is easy to use because it is composed of a user-friendly UI, and provides additional functions such as contact function and project management function.

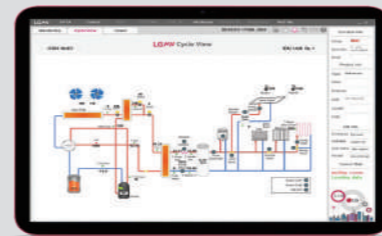

### LGMV

LGMV is a useful engineering tool that monitors Therma V's real-time refrigerant and water cycle. It assists installers with effective and efficient start-up and commissioning after the Therma V installation. LGMV enables service/field engineers to detect the errors and troubleshooting for fast and reliable problem solving.

\* LGMV is available on the LG partner portal.

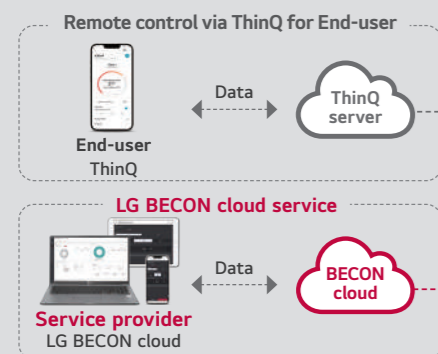

## ThinQ and BECON cloud for Control, Maintenance, and Monitoring

With ThinQ, users can regulate the temperature and operation mode of the R290 Monobloc anytime, anywhere. Additionally, the BECON cloud enables installers or service partners to provide remote monitoring, servicing, and firmware upgrades as needed.

※ The installation scene used in this leaflet is intended to visualize the product and installation manuals and local regulations must be observed.

## Product Dimensions

[Unit: mm]

### Outdoor Unit

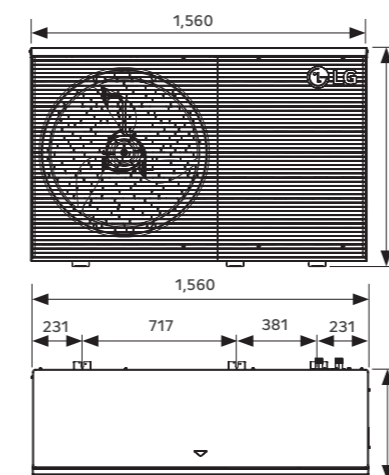

### Indoor Unit

Hydro Unit

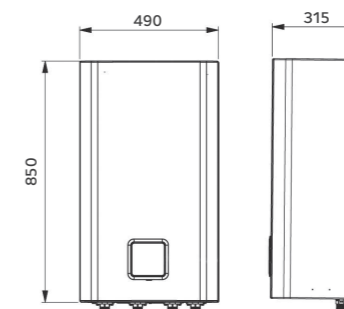

Control Unit

