



**Kotao na
BIOMASU/
Heating boiler
BIOMASS
OPERATED**

**SERIJE
TKAN/
SERIES
TKAN**



INSTRUKCIJE/ INSTRUCTION MANUAL

Montaža, koriš enje i održavanje kotla/ *Asseby, use and maintenance of heating boiler*

Sadržaj:

1. Važna upozorenja;
 - 1.1 Minimalna udaljenost od zapaljivih materijala;
2. Opis kotla;
3. Montaža;
 - 3.1 Opšta upozorenja;
 - 3.2 Mere i uređaji bezbednosti kod kotlova TKAN;
 - 3.3 Koplarnica;
 - 3.4 Priklu enje na dimnjak;
4. Presek TKAN kotla sa opisom elemenata;
5. Šema veze automatike;
6. Tabela sa tehni kim podacima;
7. Hidrauli na šema;
8. Start rada kotla i održavanje;
 - 8.1 Displej automatike;
 - 8.2 Start rada kotla na biomasu;
 - 8.3 Start rada kotla na vrsto gorivo;
 - 8.4 Kratko uputstvo za upotrebu automatike;
 - 8.5 Greške prilikom startovanja kotla;
 - 8.6 Održavanje kotla;
 - 8.7 Natpisna plo ica;
 - 8.8 Izjave;
 - 8.9 Nalepnice;
 - 8.10 Proizvo a ;
9. Garancija.

1. Važna upozorenja

OPŠTA UPOZORENJA

- Nakon uklonjenog pakovanja uveriti se u kompletnost isporuke, i u slučaju nedostataka, obratiti se prodavcu koji je prodao kotao.
- Kotao mora biti upotrebljen isključivo za namenu koju je predvideo proizvođač. Isključuje se bilo kakva odgovornost od strane proizvođača za štetu uzrokovanu osobama, životinjama ili stvarima, u slučaju grešaka pri montaži, regulaciji, održavanju ili nepravilnom korišćenju.
- U slučaju curenje vode isključiti uređaj sa električnog napajanja, zatvoriti napajanje vodom i obavestiti ovlašćeni servis ili ovlašćenog monteru.
- Ovo uputstvo je sastavni deo uređaja i mora se čuvati sa pažnjom i mora **UVEK** pratiti uređaj u slučaju promene vlasnika ili korisnika ili u slučaju priključenja na drugu instalaciju. U slučaju oštećenja ili nestanka tražiti novi primerak od ovlašćenog prodavca.



VAŽNA UPOZORENJA

Podsećamo da korišćenje uređaja na biomasu i vrsto gorivo i koji imaju kontakt sa električnom energijom i vodom zahtevaju poštovanje sigurnosnih mera i to:

- Zabranjeno je korišćenje kotla od strane dece i osoba sa ograničenim mogućnostima bez pratnje.
- Zabranjeno je korišćenje kotla na instalacijama sa radnom temperaturom većom od 110°C, i radnim pritiskom većim od 3 bara.
- Zabranjeno je korišćenje lako zapaljivih goriva (alkohol, nafta) radi bržeg paljenja drveta
- Zabranjeno je odlaganje lako zapaljivih materijala u blizini kotla i u blizini vrata za loženje. Pepeo se mora odlagati u zatvorene i nezapaljive spremnike.
- Zabranjeno je spaljivanje otpada i materijala koje sagorevanje prouzrokuje plamen ili opasnost od eksplozije (npr. plastične kese, piljevinu, ugljenu prašinu, blato itd.).
- Zabranjena je bilo kakva intervencija tehničarima (naročito se to odnosi na zamenu grejača ili proveru ispravnosti nekog drugog el. uređaja...) ili korišćenje, pre nego se kotao isključi sa električnog napajanja i to izvlačenjem utičnice iz glavnog mrežnog napajanja.
- Zabranjena je izmena na sigurnosnim elementima.
- Zabranjeno je zatvaranje ventilacionih otvora na prostoriji u kojoj se nalazi kotao. Ventilacioni otvori su neophodni za pravilno sagorevanje.
- Zabranjeno je izlaganje kotla atmosferskim neprilikama. Sam kotao nije predviđen za spoljnu montažu i ne sadrži sistem protiv smrzavanja.
- Zabranjeno je isključivanje kotla ukoliko spoljna temperatura može da padne ispod NULE (opasnost od smrzavanja).

- Voditi računa o položaju klapne sigurnosnog vazduha (detaljnije objašnjenje u poglavlju **START RADA KOTLA**).
- U slučaju intervencije na bilo kom elektro uređaju kotla, ceo uređaj isključiti sa elektro instalacije i to tako što se izvadi utičnica iz mrežnog napajanja.
- Rad sa uređajem kotla zabranjen je ljudima sa posebnim potrebama (uključujući i decu) kako fizičkim tako i mentalnim, osim uz nadzor staratelja i ljudi koji su odgovorni za njihova ponašanja.
- Deca moraju biti pod nadzorom staratelja kako se ne bi igrala sa uređajem kotla.
- Ako je oštećena strujna zaštita, mora biti zamenjena u samoj fabrici i servisirana od strane ovlašćenog servisera ili kvalifikovanih ljudi da bi se izbegao rizik od strujnog udara.

1.1 Minimalna udaljenost od zapaljivih materijala

- Obezbedite odgovarajuću udaljenost od zapaljivih materijala, ako je potrebno obezbediti zaštitu istih.
- Minimalna udaljenost od zapaljivih materijala je propisana zakonom- molimo da se o tome raspitate kod stručnih lica, koja se bave grejanjem, i dimnicima.
- Minimalna udaljenost kotla i cevi za odvod dimnih gasova od slaboprosečno gorivih materijala treba da bude najmanje 100mm.
- Minimalno rastojanje od lako zapaljivih materijala je 200mm, a isto važi i za materijale čija zapaljivost nije poznata.



Opasnost od požara!

- Skladištenje zapaljivih materijala i tečnosti u blizini kotla je zabranjeno.
- Obavezno upozorite korisnike o potrebnoj minimalnoj udaljenosti zapaljivih materijala od kotla.

Zapaljivost građevinskih materijala	
A ... nezapaljivi	azbest, kamen, građevinski kamen, keramičke zidne pločice, terakota, malter, cementna glazura (bez organskih dodataka)
B ... koji nisu lako zapaljivi	gipsane kartonske ploče, staklena vlakna, ploče od AKUMINA, IZOMINA, RAJOLITA, LIGNOSA, VELOKSA i HERAKLITA
C1 ... slaboprosečno gorivi	bukovo i hrastovo drvo, kompozitno drvo, filc, ploče od HOBREKSA, VERZALITA, UMAKARTA
C2 ... prosečno gorivi	drvo bora, tise i jele, kompozitni materijali
C3 ... lako zapaljivi	Asfalt, karton, celulozni materijali, iverica, pluta, poliuretan, polistiren, polipropilen, polietilen, podna vlakna

2.Opis kotla

Kotao TKAN je razvijen sa ciljem da RADIJATOR INŽENJERING ponudi tržištu kotao koji je po svojim mehani kim i termi kim osobinama izrazito namenjen biomasi kao gorivu. Koriste i uopšteni pojam „BIOMASA“ naravno da se pre svega misli na pelet, ali treba ista i i mogu nost loženja sa košticama vo a i to pre svega višnja, trešnja. **Ukoliko korisnik želi da koristi neki oblik biomase koji nije naveden, obavezno treba da kontaktira službu konstrukcije i razvoja Radijator inženjeringa ili ovlaš enog prodavca, jer vrlo esto pojedini oblici biomase zahtevaju posebna, specifi na rešenja sagorevanja.** Prilikom koriš enja navedenih goriva podrazumeva se automatska kontrola glavnih parametara rada. U svim navedenim primerima koriš enja biomase zahteva se odre en stepen suvo e goriva. S' druge strane zahtevi tržišta su uvek okrenuti ka što ve oj univerzalnosti goriva, tako da je TKAN mogu e ložiti i sa vrstima gorivima (drvetom, ugljem...) i tada je loženje ru no.

Samo sagorevanje se u ovoj situaciji odvija pod prinudnom promajom ventilatora, tako da je TKAN u ovim uslovima efikasniji nego njegovi prethodnici koji funkcionišu po principu slobodne promaje.

Drveni peleti su dobijeni od 100% celuloze. Ostaci drveta pod visokim pritiskom su sabijeni u pelet pre nika 6mm i dužine 2-3cm. Pelet treba pravilno skladištiti i to na suvom mestu da bi se obezbedilo efikasno sagorevanje. Kotlovi TKAN 1.1, TKAN 1.2 i TKAN 2 koriste pelet pre nika 6mm, dužine 5-30mm i vlažnosti do 10% izra en po standardu **EN 14962-2**.

Serijski kotlovi TKAN proizvodi se u tri varijante snage TKAN1.1, TKAN1.2 i TKAN2. TKAN1.1 pokriva opseg snaga od 8.10÷27 kW, TKAN1.2 je u opsegu od 8.1÷34.9 a TKAN2 je u opsegu 14.5÷49,5 kW.

Postoje važe i sertifikati kojima su potvr ene emisije gasova prilikom rada kotla na pelet, takvih sertifikata za sada nema kada se za ogrev koristi drvo pa u tom slu aju preporu ujemo ugradnju spremnika (akumulatora) tople vode za grejanje i to zapremine 55L/kW nazivne snage (na nekim tržištima npr. SLOVENIJA, ovo nije preporuka kupca ve i zakonska odredba).

KONSTRUKCIJA

Po spoljašnjem dizajnu, dimenzijama ložišta, otvorima za loženje i iš enje TKAN je zadržao sve dobre osobine predhodnih modela po kojima je RADIJATOR INŽENJERING prepoznatljiv na tržištu.

Vodeni deo kotla, njegov na in izmene toplote izme u dimnih gasova i vode, prilago en je biomasi i uglju. Zbog primene ventilatora, tj. prinudne promaje put dimnih gasova duži je nego kod standardnih kotlova. Iz istih razloga mogu a je primena usmeriva a dimnih gasova tzv. turbulatora koji dodatno pove avaju stepen iskoriš enja kotla.

Stepen korisnosti na pelet je preko 90%. Pri normalnim režimima temperatura dimnih gasova na izlazu je oko 150°C, a pri maksimalnim režimima je ispod 180°C. Ove vrednosti mogu u svakom trenutku da se očitavaju na displeju. Tokom rada dolazi do stvaranja naslaga gareži i pepela na izmenjiva kom delu kotla i to značajno utiče na slabiju izmenu i porast temperature dimnih gasova. Ako se kotao ne čisti duže vreme moguće je toliki porast temperature dimnih gasova da dolazi do prekida rada kotla. Svaka veličina TKAN kotla poseduje bakarni izmenjivač za priključivanje ventilatora za termičko osiguranje kao i klapnu za potpalu. Svi delovi vodenog dela kotla izrađeni su od bešavnih cevi kvaliteta **ST 35.4** i kotlovskih limova debljine 5mm, u zavisnosti od snage kotla. Limovi su kvaliteta **1.0425 EU** standard odnosno **P265GH** standard **EUII**.

Ložište je po svojem principu rada tzv. „izviruće“, gde gorivo iz zone transporta ide vertikalno uvis tj. izvire do zone sagorevanja. Napravljeno je od masivnih izolacijskih materijala i sivog liva. Transport goriva obezbeđen je pužnim transporterima. Gorivo dolazi iz silosa zapremine 240 L. U slučaju potrebe vrlo je lako demontirati ceo sklop u tri nezavisne celine: silos, mehanizam za nalaganje i kotao.

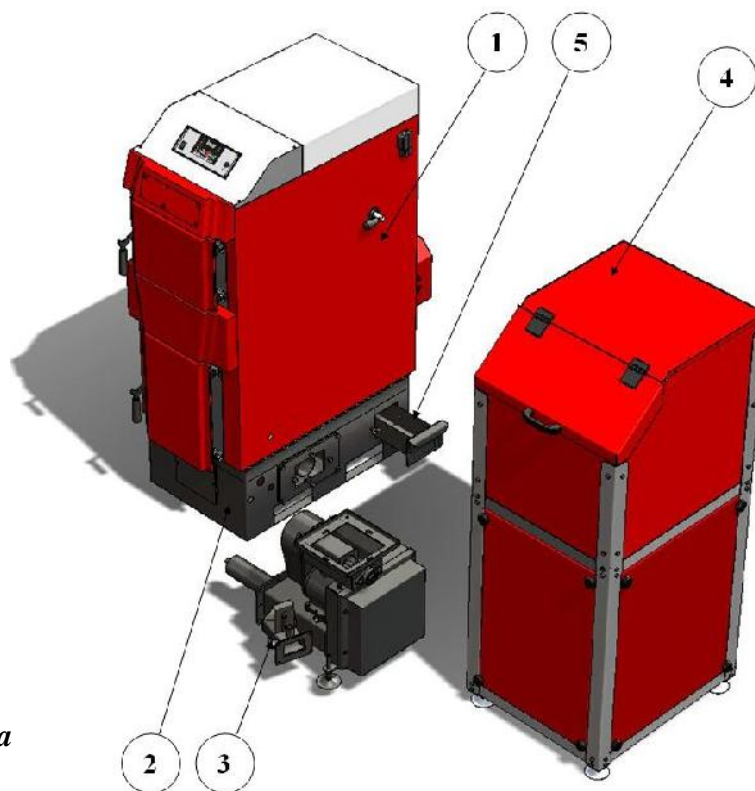

Slika 1. Delovi kotla

Opis:

1. Telo kotla;
2. Ložište;
3. Dozer;
4. Silos;
5. Pepeljara

3. Montaža

3.1 Opšta upozorenja

Kotao mora biti pravilno postavljen zbog pravilnog rada!

Kotao se isporučuje sa spoljnom oblogom koja sadrži izolaciju debljine 30mm.

Položaj silosa i mehanizma za transport peleta je standardno fabrički desni u odnosu na kotao.

Moguće je naručiti da se u fabrici sklopi i leva varijanta. Takođe, ako je potrebno lako je promenu izvršiti i na terenu jer je silos i ceo mehanizam dozatora demontažan u odnosu na kotao. Elektro priključci su konektorskog tipa tako da za njihovo rastavljanje i ponovno sastavljanje nije potrebno osoblje specijalizovane elektro struke.



Silos za TKAN 1.1, TKAN 1.2 i TKAN 2 imaju fleksibilnu vezu sa mehanizmom za transport, a sve to kako bi se izbegle vibracije tokom rada . (slika 2.)

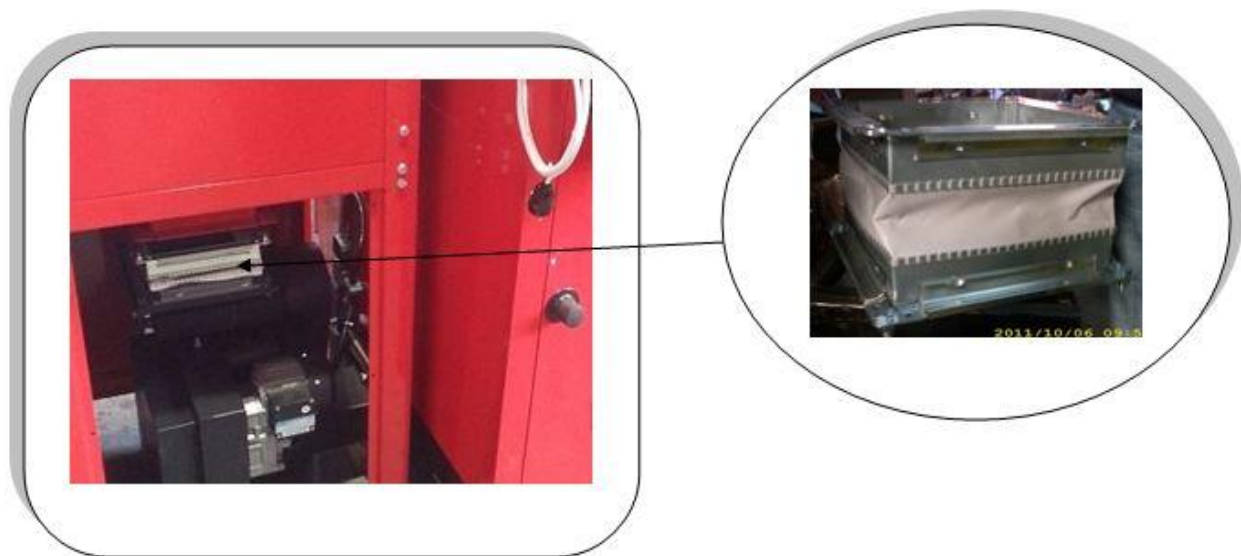

Slika2. Prikaz fleksibilne veze



Maksimalni radni pritisak kotla je 3 bar-a, minimalni 1 bar, a maksimalna radna temperatura kotla je 110° C.



Kotao je sa ventilatorom i automatikom i oba uređaja koriste napajanje 230V, tako da nepravilno instaliranje i neoprezno rukovanje mogu da ugroze ljudski život strujnim udarom.



Kotao na vrsto gorivo i prinudnom promajom treba instalirati prema važe im normama i zakonskim propisima. Svaka izmena ili na mehani koj konstrukciji ili na elektri noj instalaciji smatra e se narušavanjem garancijiskih uslova i doveš e do njenog narušavanja.



Prilikom montaže na hidrauli ku instalaciju kotao mora biti obezbe en na propisan na in od prekora enja maksimalne radne temperature i pritiska.



Za propisnu montažu odgovoran je instalater centralnog grejanja koji priklju uje kotao na hidrauli ki sistem.



Radijator inženjering ,kao proizvo a kotla, ne preuzima nikakvu odgovornost za štete prouzrokovane lošim instaliranjem kotla.

Osnovni zahtevi koje treba ispoštovati prilikom montiranja su:

- Kotao može da bude priklju en na otvoreni sistem centralnog grejanja, ali i na zatvoren sistem centralnog grejanja. U slu aju priklju enja na zatvoreni sistem ,preporu uje se ugradnja ventila za termi ko osiguranje oticanjem, što je odre eno i odgovaraju im zakonima svake države u kojoj se kotao priklju uje.
- Kotao mora da se nalazi na sigurnoj udaljenosti od lako zapaljivih materijala.
- Elektri no napajanje kotla je 230V i 50Hz i priklju enje svih ure aja koje kotao sadrži treba uraditi prema vaze im propisima i priklju enje radi lice sa odgovaraju im ovlaš enjem.
- Priklju enje na dimnjak tako e se radi prema obavezuju im propisima kao i preporukama proizvo a a što se može videti u narednom tekstu.

3.2 Mere i uređaji bezbednosti kod kotlova TKAN

Za bezbedan rad kotla potrebno je ugraditi i održavati ih ispravnim sledeće elemente:

- Ventil sigurnosti na pritisak (slika 3)



Slika 3.



Slika 4.



Slika 5.

- Ventil sigurnosti na pritisak mora biti nazivnog prenika 1/2 col a baždaren na maksimalno 3 bara.
Ovaj sigurnosni element koji spada u grupu limitatora pritiska mora da bude takve konstrukcije da izdrži i kratkotrajna prekoračenja i temperature i pritiska kao i određen sadržaj glikola u tečnosti za grejanje.
Obično na istom mestu se priključuju još i odzračivač (slika 4.) i manometar (slika 5.) tako da ova tri elementa zajedno sačinjavaju sigurnosnu grupu i montiraju se preko „T” priključka.
Ovaj sigurnosni element mora da podleže i periodičnim ponovnim baždarenjima o čemu investitor tj. korisnik kotla mora da poseduje validnu dokumentaciju.
- Ventil sigurnosti mora biti montiran na najvišoj tački kotla i direktno na kotlu bez bilo kakvog cevovoda ili bilo kojih drugih elemenata između. Za ovu svrhu postoji i posebno predviđen priključak (videti sliku 7.). Strogo je zabranjeno bilo kakvo reduciranje prenika ovog priključka.
- Ispusni tj. izduvni deo ventila sigurnosti mora da bude od cevi čiji je prenik najmanje jednak nazivnom preniku ispusnog dela ventila. Tako je dozvoljeno je za njegovu izradu koristiti najviše jedan luk radijusa $r > 3d$.
- Sigurnosni ventil mora posedovati nazivnu pločicu i na njoj sledeće podatke:
 - naziv proizvođača
 - oznaka tipa sigurnosnog ventila/godina ispitivanja
 - nazivni protok
 - podatak za koji toplotni učinak je sigurnosni ventil podešen
 - najviši pritisak otvaranja tj. 3 bara
- Obavezna je provera ispravnosti rada u određenim vremenskim periodima kao i ponovna baždarenja od strane sertifikovanih firmi. Ove obaveze se sprovode u skladu sa zakonom svake zemlje u kojoj je kotao namontiran. Obavezno čuvati pisani dokument o podacima zadnjeg baždarenja sigurnosnog ventila.
- Na povratnom vodu montirati barem još jedan ventil sigurnosti na pritisak.

- Ventil termi kog osiguranja oticanjem (slika 6)



Slika 6.

Ovaj sigurnosni element ima tako e ulogu ograni iva a temperature.U daljem tekstu bi e ozna en sa skra enicom VTO.

- U nekim ekstremno opasnim situacijama prelaz vode u vodenu paru je takav da ventili sigurnosti za pritisak nisu dovoljni da obezbede sigurnost hidrauli kog sistema. Iz ovog razloga je obavezna ugradnja VTO.U zavisnosti od zakonskih regulativa zemalja u kojima se kotao montira, VTO je potrebno ugraditi samo za snage ve e od odre enih ili za svaku snagu kotla obavezno ugraditi VTO.
- Mesto ugradnje prikazano je na šemi montaže kotla na instalaciju i na **slici 7**.

U kotlu se isporu uje bakarna spirala tako da je potrebno koristiti VTO sa izmenjiva em kao na **slici 7**.Do VTO-a se dovodi hladna sanitarna voda.Kada sonda VTO-a ima informaciju da je temp. preko 95 stepeni VTO se otvara i voda prolazi kroz bakarnu spiralu.Posle izvesnog vremena temp. vode u kotlu se vra a na normalnu.

- Jedan priklju ak spirale koristimo za VTO a drugi za ispust vode koja je prošla kroz spiralu.Koji je priklju ak spirale za VTO a koji je ispusni je nebitno. Obavezno je pridržavati se uputstava ugradnje koje je dao proizvo a VTO
- Obavezno u odre enim vremenskim periodima proveravati funkciju VTO.

Kao što je ve re eno jedan kraj VTO je za montažu na izmenjiva kotla a do drugog se dovodi hladna voda pod pritiskom. Naro ito je bitno da protok te vode bude neometan i pri nestanku el. energije.



Ukoliko je nemogu e obezbediti dotok hladne sanitarne vode i pri nestanku el.energije,obavezno kotao priklju iti na otvoren sistem.

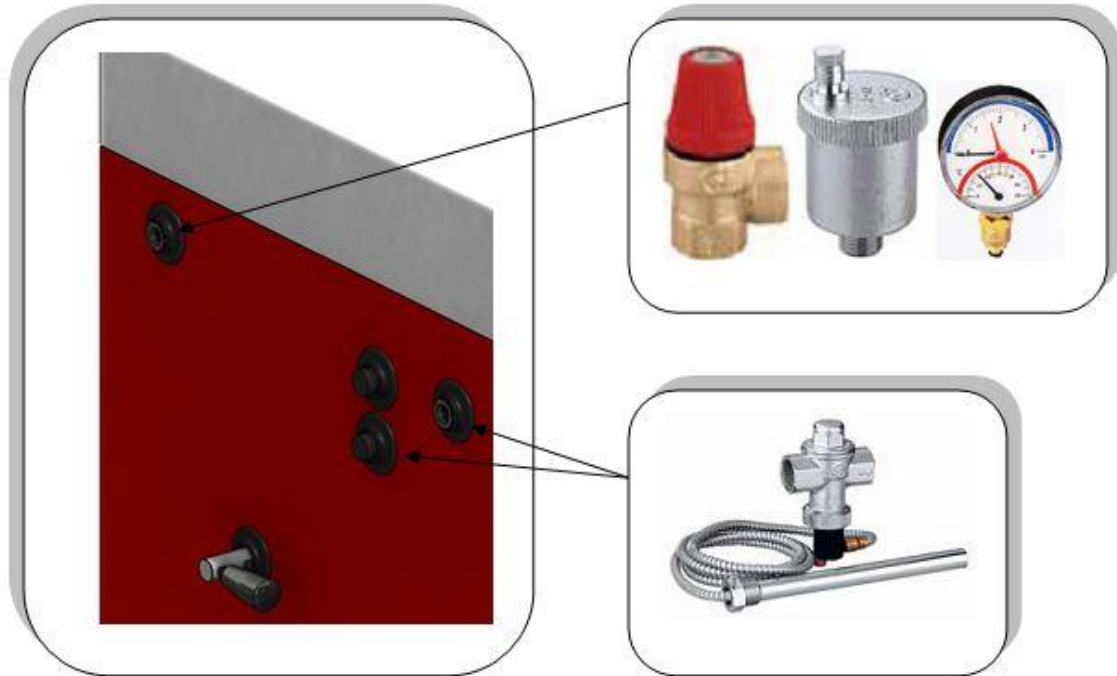

Slika 7. Prikaz postavljanja sigurnosnih elemenata

Termostati u automatici kotla

- U samoj automatici koja vodi proces sagorevanja i utiče na rad dva kruga grejanja postoje dva termostata. Oba su slične konstrukcije kao termostat prikazan na **slici 8.** i imaju i sigurnosne funkcije kao limitatori temp. vode u kotlu. Zbog sigurnosne uloge u funkcionisanju kotla oba termostata imaju nezavisne sonde za merenje temperature vode. Prvi termostat je tzv. radni i on služi da ograniči temperaturu do nivoa koji želi korisnik. Drugi termostat je sigurnosni jer prekida rad ventilatora koji pospešuje plamen, odnosno dodaje novu energiju. Sigurnosna temperatura je ograničena na 95 stepeni Celzijusa.

Pumpu za grejanje je veoma važno priključiti preko automatike iz sigurnosnih razloga. Kada temp. vode u kotlu dostigne kritičnu vrednost od 95 stepeni ventilator staje sa radom ali pumpa se obavezno uključuje kako bi razmenila toplotu vode kroz radijatore.

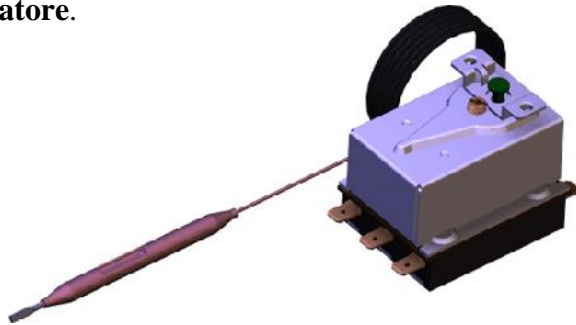

Slika 8.

3.3 Kotlarnica

Kotlarnica mora biti obezbeđena od smrzavanja.

Podloga za kotao u kotlarnici mora biti od nezapaljivog materijala. Preporučene vrednosti udaljenosti sve četiri strane kotla u odnosu na zidove kotlarnice ili neka druga kruta tela (akumulacioni bojler itd.) prikazane su na **slici 9**. Ove vrednosti udaljenosti omogućavaju siguran pristup prilikom loženja, dovoljan prostor za išćenje i nesmetan pristup ventilatoru i ventilu za punjenje i pražnjenje. Kotao sa svoje leve strane treba da bude udaljen od zida 200mm tj. onoliko koliko je potrebno prostora za prikljućenje ventila za termičko osiguranje oticanjem. Ako se ventil ne ugrađuje onda prostor može da bude i manji. Ručica klapne za potpalu je demontažna i može se staviti i na levu i na desnu stranu kotla. Prostor sa desne strane kotla, koji se preporučuje da bude barem 800mm od silosa bitan je iz razloga što posle išćenja kotla korisnik tada prolazi i izvlači pepeljaru iz zadnjeg dela ložišta. Kotlarnica mora da poseduje dovoljne otvore za ventilaciju kako za svež vazduh tako i za odvođenje istrošenog vazduha.

Kotlarnica mora da poseduje dovoljne otvore za ventilaciju kako za svež vazduh tako i za odvođenje istrošenog vazduha!

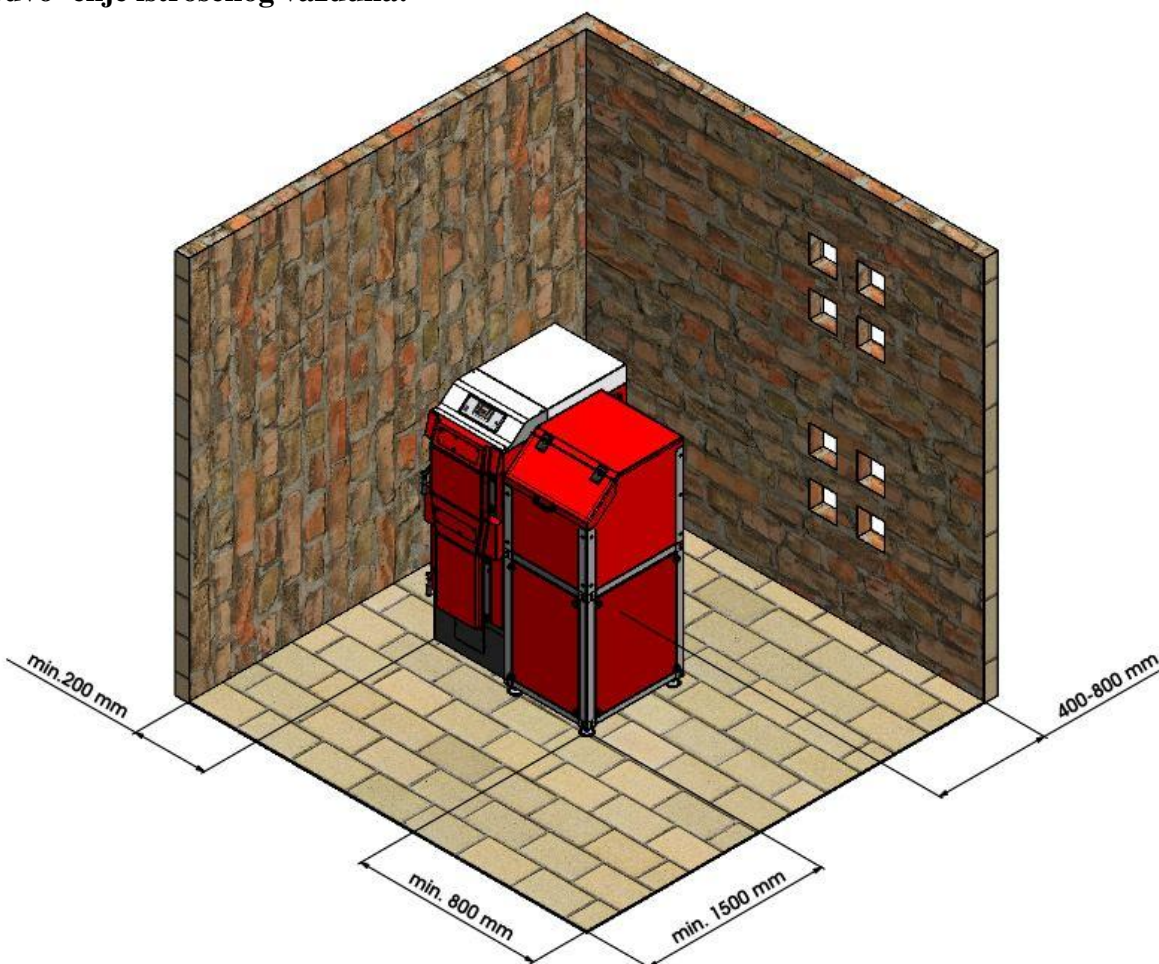

Slika 9. Pozicioniranje kotla u kotlarnici

Ukupna površina ovih otvora je minimalno 150cm² za snage do 50kW a za snagu preko 50kW površina mora biti veća a za još 2cm² po kilovatu.

$$A = 150\text{cm}^2 + \frac{2\text{cm}^2}{\text{kW}} \times (\sum Q_n - 50\text{kW}) \quad \sum Q_n = \text{moguće snage preko 50kW.}$$

Nedostatak dovoljne ventilacije u kotlarnici može da uzrokuje više problema u radu kotla. Glavni problem je nemogućnost postizanja visokih temperature izlazne vode tj. ne postizanje maksimalne snage što dovodi do kondezovanja u kotlu.

- Uzeti u obzir neophodan minimalni prostor koji je potreban za prilaz sigurnosnim elementima i za izvršenje operacija išćenja.
- Utvrditi da li je stepen električne zaštite u skladu sa karakteristikama prostorije u kojoj će kotao biti smešten.
- Zabranjeno je izlaganje kotla atmosferskim nepravilnostima. Sam kotao nije predviđen za spoljnu montažu i ne sadrži sistem protiv smrzavanja.
- Zabranjeno je zatvaranje ventilacionih otvora na prostoriji u kojoj se nalazi kotao. Ventilacioni otvori su neophodni za pravilno sagorevanje.

3.4 Priklu enje na dimnjak

Kotao TKAN radi sa prinudnom promajom, ali ipak treba ispoštovati pravila za odabir dimnjaka kao da se radi o kotlu sa natpritiskom u ložištu na neko drugo gorivo, kao na lož ulje na primer. U suprotnom može doći do problema u radu, naročito u fazi potpale i u režimu rada na vrstu gorivo.

Preporuka je da prenik dimnjaka bude barem jednak preniku dimnjaka kotla a minimalna visina 7 do 8 metara, sve u zavisnosti od pokrivenosti dimnjaka nekim drugim visokim građevinama pored njega.

Najoptimalnije postavljanje kotla na dimnjak je takvo da prava koja spaja centar izlaza dimnih gasova iz kotla i centar prikljuenja na dimnjak bude u blagom usponu (do 3%)

(pogledati **sliku 10**).

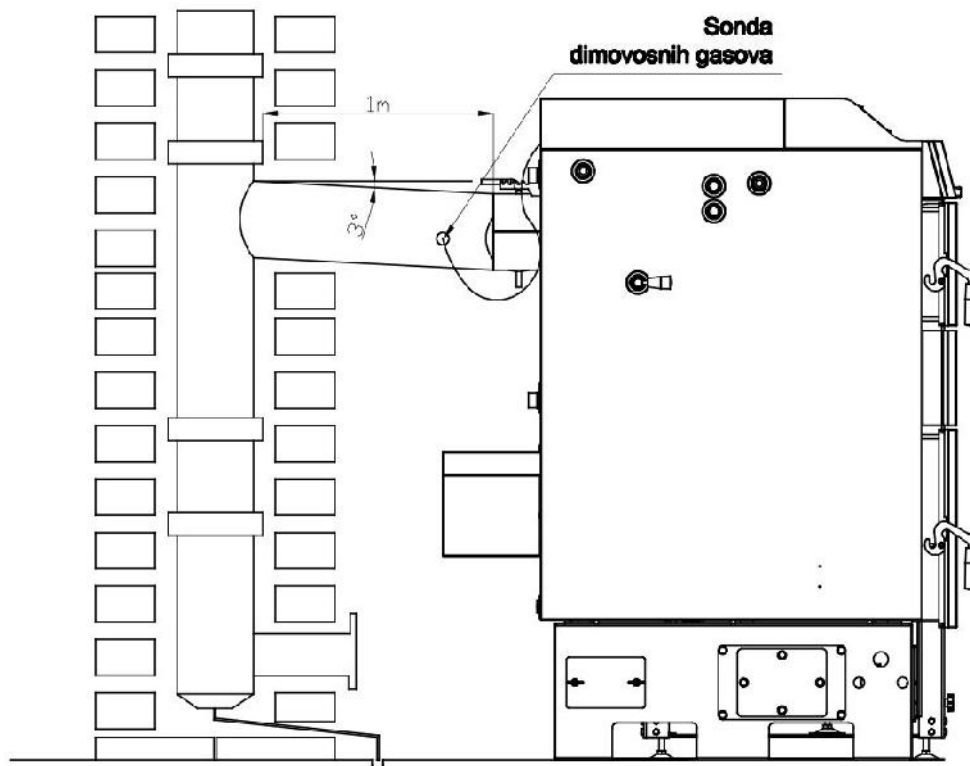

Slika 10. Prikaz prikljuenja na dimnjak

Treba izbegavati ako je moguće lukove, a ako nije onda je maksimalni broj lukova (2). Dimni kanal od kotla do dimnjaka poželjno je izolovati, posebno ako ima lukova i dužih deonica.

Na dimnoj cevi, približno 100mm od dimnjaka kotla, treba izbušiti otvor i montirati uložak za temperaturnu sondu dimnih gasova. Bez informacije o temperaturi dimnih gasova nema ni automatskog režima rada kotla.

Sam dimnjak treba da je napravljen od kerami kih cevi, oko njih treba da je izolacija debljine 3-5cm i zadnji spoljni sloj je cigla ili specijalni dimnja ki elementi. Ako dimnjak ipak nije od keramike ve od cigle, površina svetlog preseka takvog dimnjaka mora da bude 30% ve a nego ovakva površina kerami kog dimnjaka.

Dimnjak mora da ima i vratanca za iš enje a ona moraju dobro da dihtuju. Izlaz dimnjaka na krovu mora da bude po odre enim propisima. Razlikuju se dva slu aja: ako je ugao krova manji od 12 i ako je ugao krova veci od 12 . Za ugao manji od 12 visine dimnjaka iznad krova je 1m a za ugao veci od 12 treba pogledati skicu.

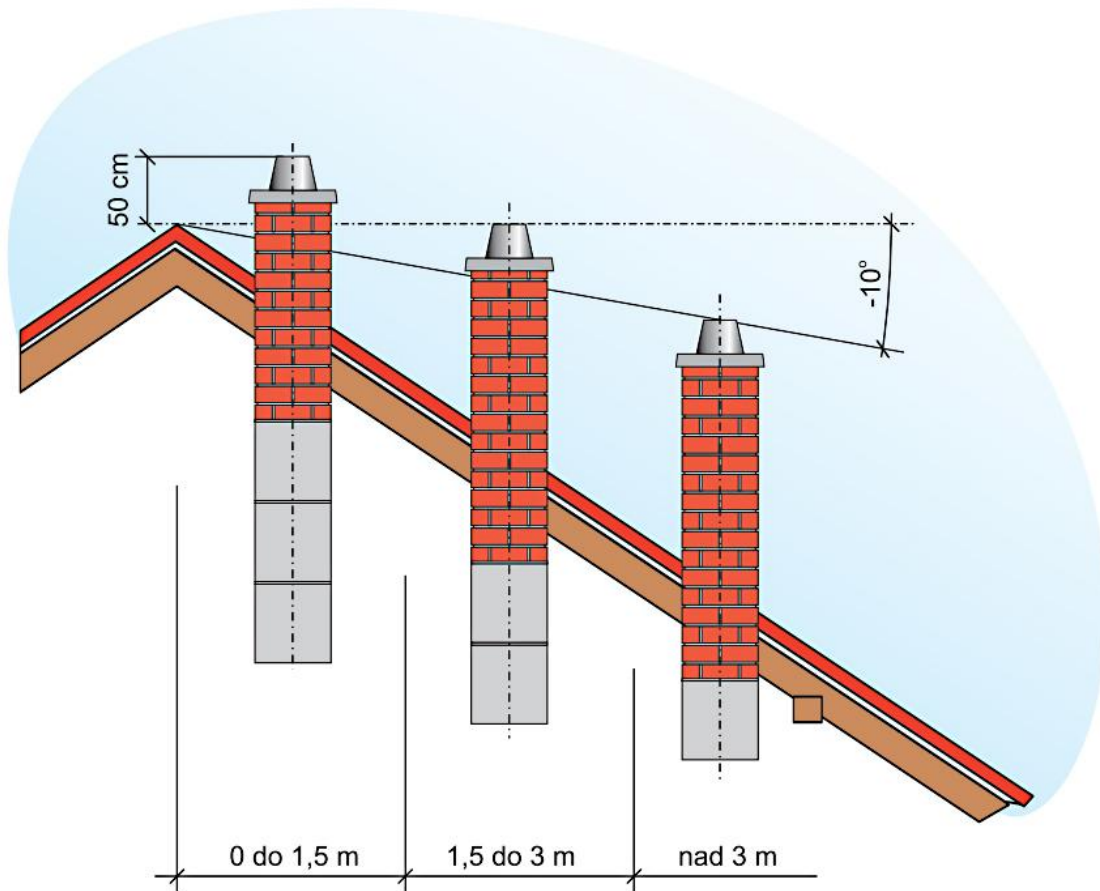

Ukoliko mislite da je dimnjak prejak i da isuviše hladnog vazduha prolazi kroz kotao, na izlazu iz kotla postoji klapna kojom može da se smanji protok izduvnih gasova.

Dimnjak treba redovno da se ist ili barem jedanput godišnje.



Ukoliko dimnjak nije propisne visine, poprečnog preseka ili ako se ne ističu moguće komplikacije u radu kotla. Pre svega nije moguć visokotemperaturni režim rada, tj. nema maksimalne radne snage, a posledice toga je pojava kondenzacije što utiče na radni vek kotla.



Slab dimnjak je glavni razlog da u toku potpale kotla ili u toku rada imamo pojavu dima na gornjim ili donjim vratima, naročito pri većim brojevima obrtaja ventilatora.

4. Presek TKAN kotla sa opisom elemenata

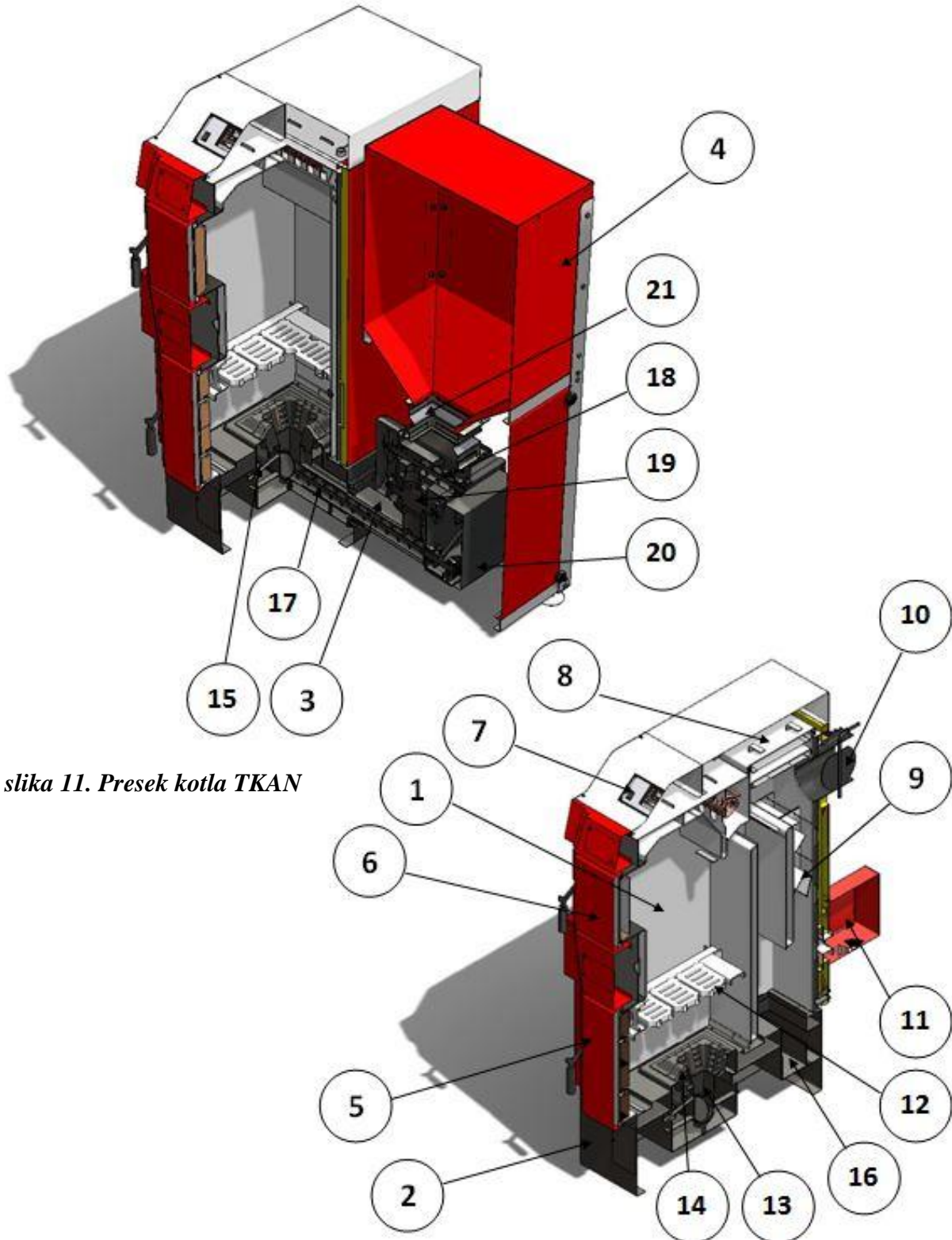

slika 11. Presek kotla TKAN

Opis:

1. Telo kotla;
2. Ložište;
3. Dozer;
4. Silos;
5. Donja vrata za potpalu i iš enje;
6. Gornja vrata za loženje;
7. Automatika;
8. Poklopac otvora za iš enje;
9. Turbulatori;
10. Dimnja a;
11. Sekundarni ventilator;
12. Rešetke (livenne rešetke za drvo)
13. Ložište za pelet;
14. Liveni segmenti;
15. Greja ;
16. Pepeljara;
17. Donji pužni transporter;
18. Gornji pužni transporter;
19. Rotacioni sigurnosni element;



20. Kutija sa ležajevima i lan anicima;
21. Fleksibilna veza.

5. Šema povezivanja automatike

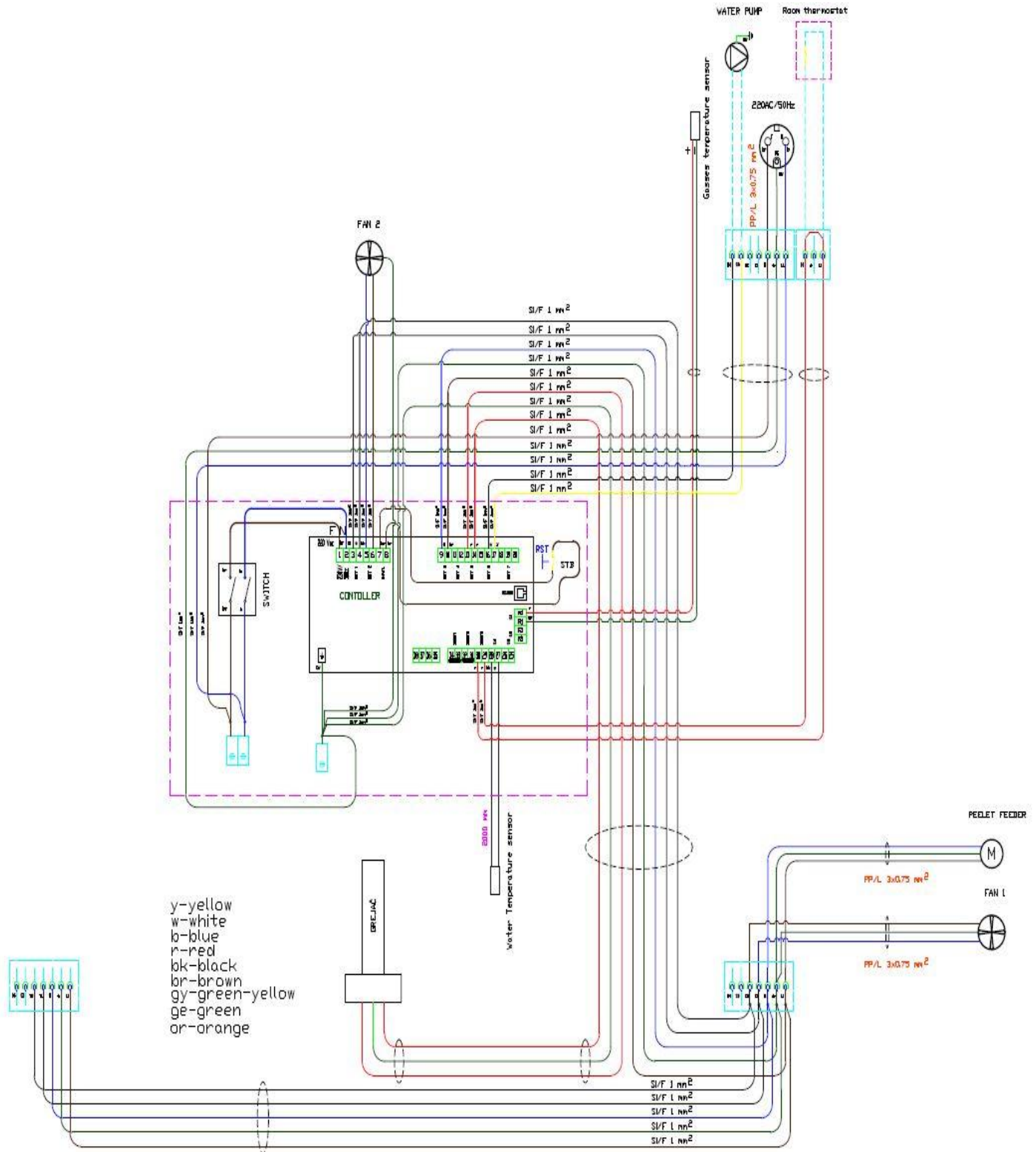

Sve linije koje su prikazane isprekidano na šemi spoljnih priklju enja su provodnici koje je potrebno da instalira tehni ko lice prilikom priklju enja spoljnih ure aja na automatiku kotla. Sva priklju enja dodatnih ure aja tehni ko lice obavlja preko dva konektora koja se nalaze na zadnjem delu kotla. Jedan konektor je trolpolni a jedan je sedmopolni. Trolpolni je za priklju enje sobnog termostata što je prikazano na nalepnici samog konektora.

 ***Za sobne termostate bitno je da budu sa baterijskim napajanjem tj. da nemaju na sebi bilo kakav dovod napona 220 V. Na samom termostatu za povezivanje se koristi NC (normalno zatvoreni kontakt).***

Sedmopolni konektor je za priklju eni mrežni kabal i za priklju enje cirkulacione pumpe i pumpe akumulatora odnosno bojlera za sanitarnu vodu.

 **Kotao može da radi i u slu aju da nije priklju ena pumpa za *centralno* grejanje, ali preporuka proizvo a a je da se ona ipak priklju uje jer ima funkciju sigurnosnog elementa. Uklju uje se kada temperatura vode u kotlu preraste 90°C.**

6. Tabela sa tehni kim podacima

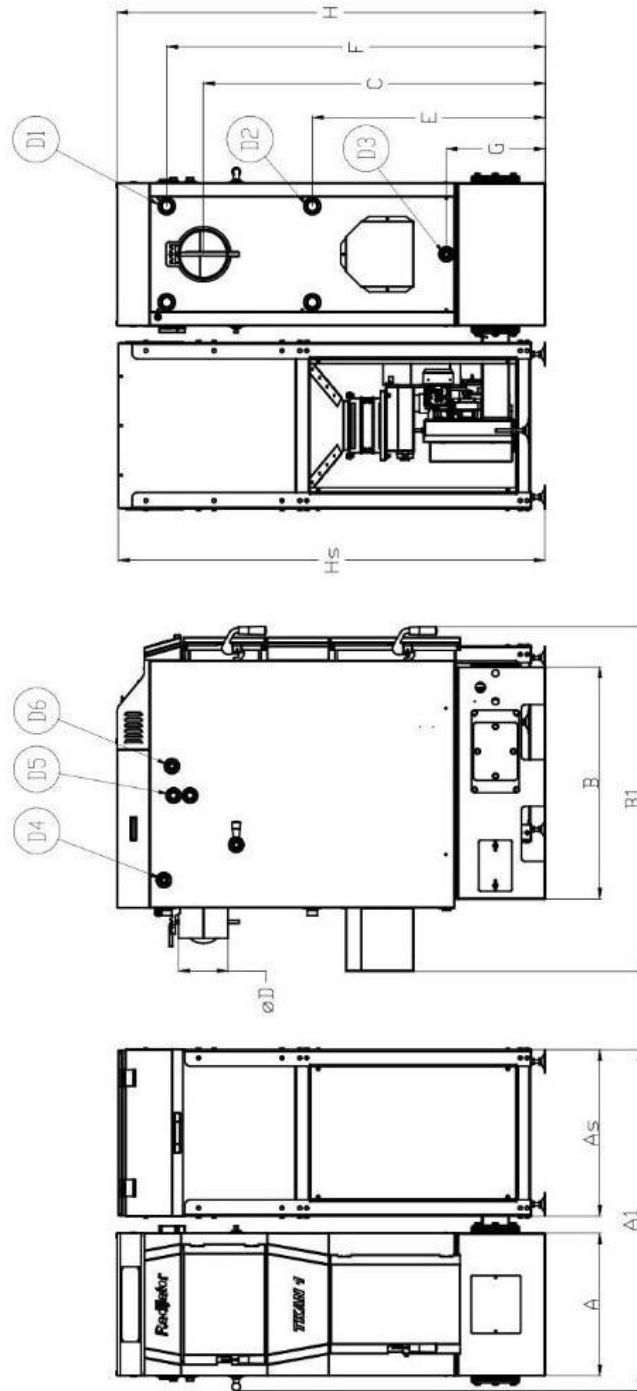

TIP KOTLA		TKAN 1.1	TKAN 1.2	TKAN 2
CE oznaka		CE	CE	CE
Klasa kotla po EN 303-5:2012		5	5	5
Radni pritisak	bar	3	3	3
Probni pritisak	bar	4,5	4,5	4,5
Zapremina ložišta	L	50	50	80
Zapremina vode u kotlu	L	97	97	125
Težina	kg	635	635	787
Popre ni presek dimnjaka	mm	180	180	200
Potrebna promaja dimnjaka	mbar/Pa	0,18/18	0.18/18	0,18/18
Temperatura kotla (min / max)	°C	60-90	60-90	60-90
Minimalna temperatura povratnog voda	°C	60	60	60
Stepen iskoriš enja pri nominalnoj/minimalnoj toplotnoj snazi	%	92,45/92	91.78/92.56	90,05/90,01
Nominalna snaga	kW	27	34.9	49,5
Minimalna/ Maksimalna snaga kotla	kW	8,1-27	8.1-34.9	14,5-49,5
Emisija ugljen monoksida (Co) pri minimalnoj toplotnoj snazi (10%O2)	mg/m3	131	114.38	122
Emisija ugljen monoksida (Co) pri nominalnoj topl.snazi (10%O2)	mg/m3	300	100.69	101
Emisija prašine pri nominalnoj/minimalnoj toplotnoj snazi (10%O2)	mg/Nm3	22,2/ 28,29	16.96/ 17.42	16,25/ 18,01
Dimenzije				
	A	520	520	670
	A1	1210	1210	1340
	As	610	610	610
	B	845	845	960
	B1	1270	1270	1325
	C	1245	1245	1350
	ØD	180	180	200
	E	850	850	470
	F	1380	1380	1465
	G	360	360	360
	H	1560	1560	1670
	Hs	1560	1560	1560
	Priklju ak za toplu vodu iz kotla	D1	1"	1"
	Priklju ak za hladnu vodu kotla	D2	1"	1"
	Priklju ak za punjenje i pražnjenje	D3	1/2"	1/2"
	Priklju ak za sigurnosnu grupu	D4	1/2"	1/2"
	Priklju ak za ventil termi kog osiguranja oticanjem	D5	1/2"	1/2"
	Priklju ak za sondu ventila termi kog osiguranja	D6	1/2"	1/2"

7. Hidrauli na šema

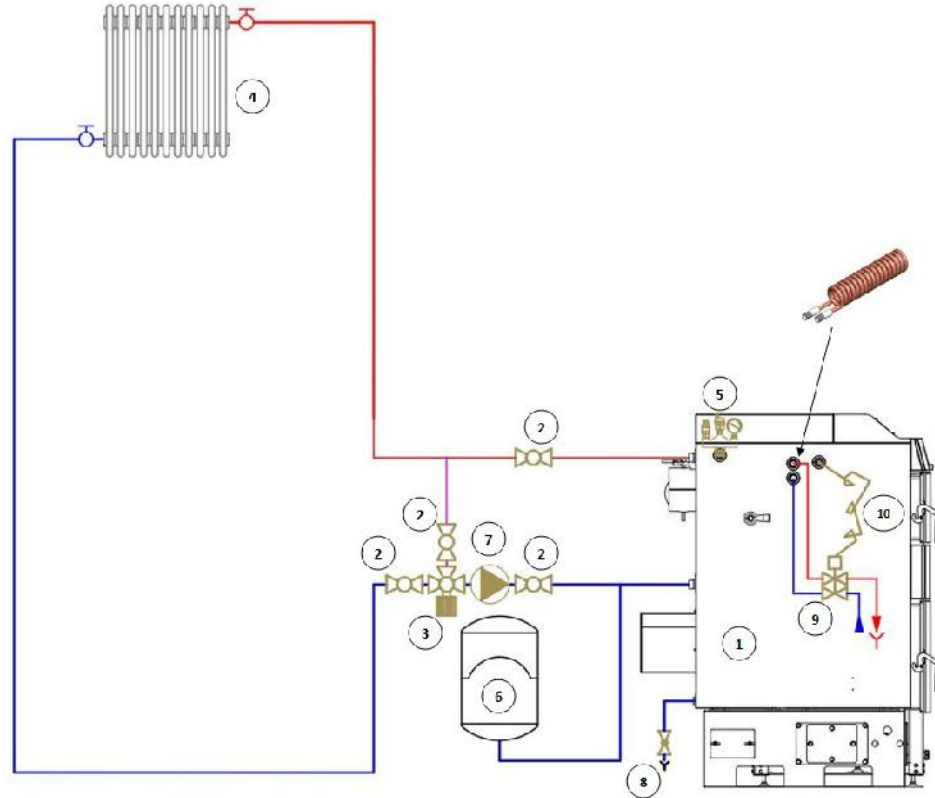

Hidrauli na šema

Opis:

1. Kotao TKAN;
2. Ventil;
3. Mešni ventil;
4. Izmenjiva ;
5. Sigurnosna grupa;
6. Ekspanziona posuda;
7. Pumpa;
8. Ventil za punjenje/praznjenje;
9. Ventil termi kog osiguranja;
10. Sonda ventila termi kog osiguranja.

 **Prilikom montaže na hidrauli ku instalaciju kotao mora biti obezbe en na propisan na in od prekora enja *maksimalne radne temperature i pritiska.***

! Za propisnu montažu odgovoran je instalater centralnog grejanja koji priključuje kotao na hidraulički sistem.

! Radijator inženjering, kao proizvođač kotla, ne preuzima nikakvu odgovornost za štete prouzrokovane lošim instaliranjem kotla.

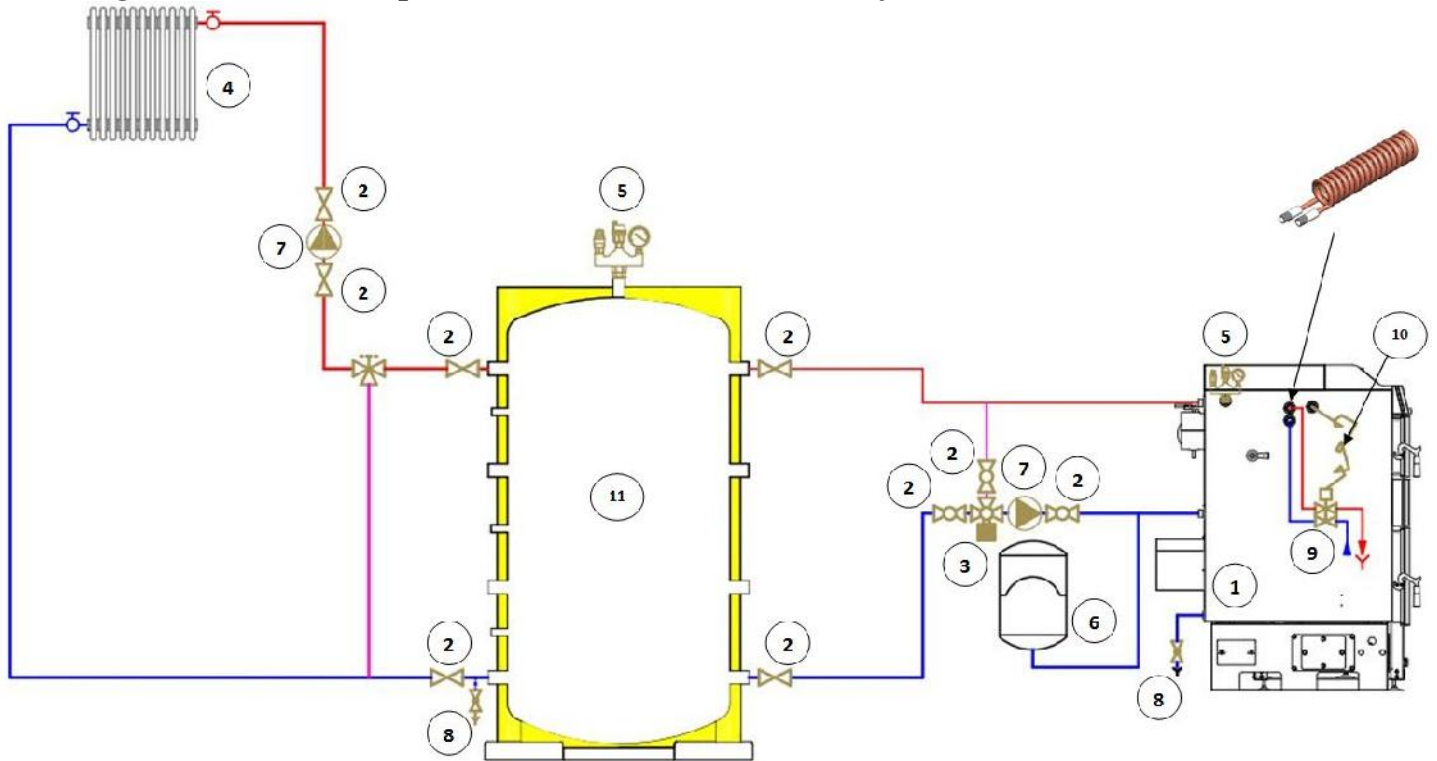

Hidraulična šema sa akumulatorom

Opis:

1. Kotao TKAN;
2. Ventil;
3. Mešni ventil;
4. Izmenjiva ;
5. Sigurnosna grupa;
6. Ekspanziona posuda;
7. Pumpa;
8. Ventil za punjenje/praznjenje;
9. Ventil termičkog osiguranja;
10. Sonda ventila za termičko osiguranje;
11. Akumulator.

8. Start rada kotla i iš enje



Prvo puštanje kotla u rad obavlja tehni ko lice koje ima sertifikat izdat od strane Radijator inženjeringa. Obavezna je obuka korisnika kotla.

Na taj na in to lice je ovlaš eno da prijavi servisnoj službi u samoj fabrici vreme kada je kotao po eo da radi i u kakvom je stanju kotao bio prilikom prvog paljenja, dok kopiju izveštaja o puštanju kotla u rad zadržava. Garancija i upustvo za upotrebu se daje kupcu. Jedan primerak garancije se šalje proizvo a u.

Ako garancija nije ispunjena, ona nije važe a.

Samo kotlovi koji su pušteni u rad od strane ovlaš enog tehni kog lica podležu uslovima kompletne garancije od dve godine.

Naredni tekst je namenjen samom korisniku kotla, kao jedna vrsta podsetnika, da ako ugasi kotao (npr. zbog iš enja) bude u stanju da samostalno pokrene kotao.



Parametri vezani za rad kotla a koji su dostupni korisniku su na samom displeju. Ostale parametre koji su u tzv. skrivenom meniju ne treba menjati bez saglasnosti tehni kog lica koje je pustilo kotao u rad ili same fabrike.

8.1 Displej automatike

Komandni panel sa injavaju:

Glavni prekidač, dugme sigurnosnog termostata, displej, grupa komandnih tastera (dugmića), grupa svetlosnih dioda pokazivača

Sljedeća slika je prikaz kontrolnog panela.

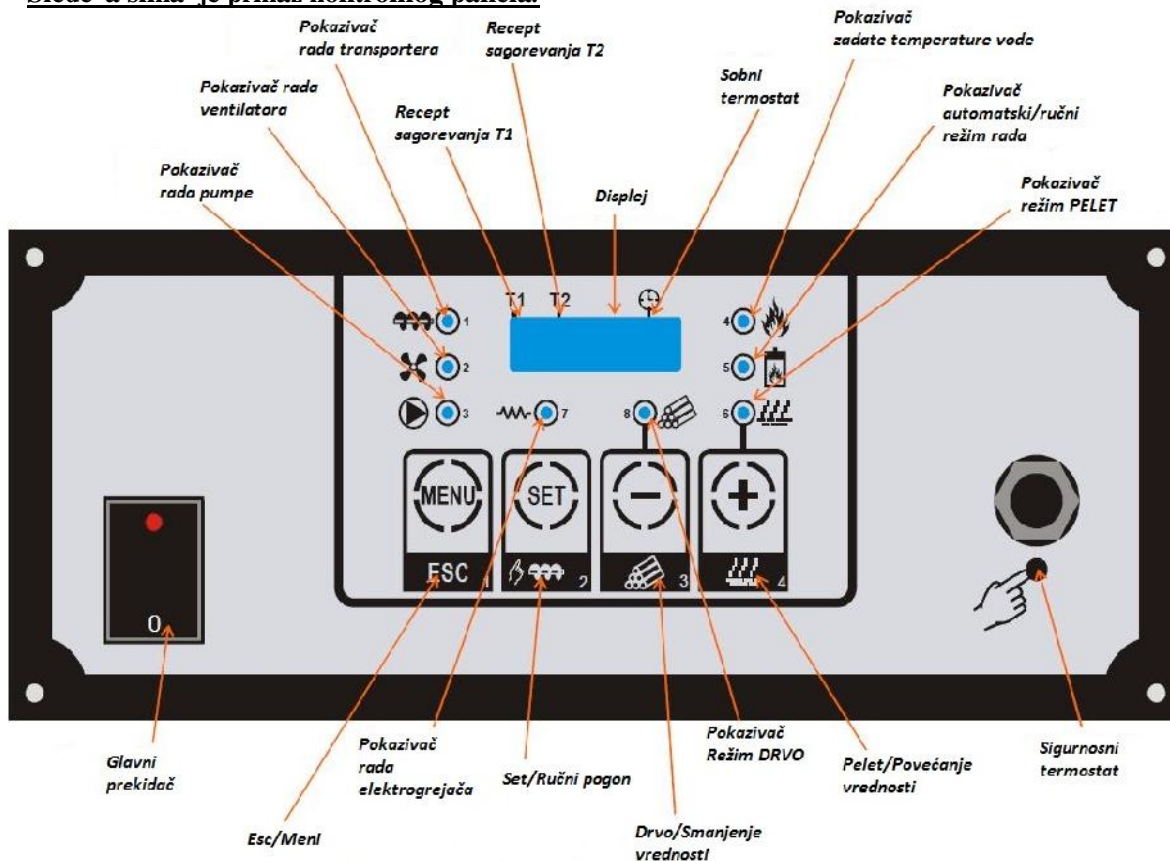

8.1.1 Komandni tasteri

U DONJEM DESNOM UGLU SVAKOG KOMANDNOG TASTERA OZNAČEN JE BROJ.

- **UKLJ.-ISKLJ.PELET/+KOMANDNO DUGME 4** : Uključuje rad sistema na pelet kao gorivo kada se drži neprekidno 5 sekundi. Takođe isključuje sistem iz rada gde se kao gorivo koristi pelet držeći ovaj taster neprekidno 5 sekundi. Pritiskom u **Meniju (Menu)** povećava vrednost parametara.

- **UKLJ.-ISKLJ.DRVO/- KOMANDNO DUGME 3** : Uključuje rad sistema na vrstu gorivo kada se drži neprekidno 5 sekundi. Takođe isključuje sistem iz rada na vrstu gorivo držeći ovaj taster neprekidno 5 sekundi. Pritiskom u **Meniju (Menu)** snižava vrednost parametara.

- **SET/Puž KOMANDNO DUGME 2** : Kada se neprekidno drži pritisnutim u režimu ISKLJUČENJE uključuje se ručno punjenje ložišta peletom. Tokom ove radnje na displeju će biti prikazan natpis “LoAd”. Ručno punjenje ložišta peletom se završava kada pustite ovaj taster.

Pritiskom u **Meniju (Menu)** menja prikaz od koda parametara do vrednosti i odobrava se sa uvanje novog podešenja.

- **ESC/Menu KOMANDNO DUGME 1** : Ovim tasterom se ulazi/izlazi iz **Menija (Menu)**. Ukoliko menjate podešavanja i pritisnete ovo dugme, promene u podešavanjima ne e biti sa uvane.

NAPOMENA:

U režimu **Isklju en (OFF)** ili u režimu **Gašenje** možete resetovati prikaz Alarma pritiskom na tastere + ili -, ali ako je uzrok alarma i dalje prisutan alarm e se ponovo uklju iti.





8.1.2 Svetle e diode

1. **Svetle a dioda Puž: UKLJU ENA** kada je ventilator za pomaganje sagorevanja radi.
2. **Svetle a dioda Ventilator: UKLJU ENA** kada je ventilator za pomaganje sagorevanja radi.
3. **Svetle a dioda Pumpa P: UKLJU ENA** je kada pumpa radi. **TREP E** kada je pumpa isklju ena od strane sobnog termostata.
4. **Svetle a dioda Kotao: UKLJU ENA** kada je temperatura vode u kotlu ispod vrednosti **T-KOTAO[A03]– ModulacijaDelta1[A05]**. **TREP E** kada je temperatura vode u kotlu iznad zadate temperature. **ISKLJU EN** kada je temperatura vode u kotlu iznad temperature **T-KOTAO[A03]**.
5. **Svetle a dioda Izduv** : **UKLJU ENA** kada je temperatura izduva iznad **T-IZDUV-UKLJ[F18]**. **TREP E** tokom režima predgašenje.
6. **Svetle a dioda Pelet** : **UKLJU ENA** kada kotao radi na u modu pelet. **TREP E** tokom režima predgašenje(**Vreme predgašenja[t06]**).
7. **Svetle a dioda Greja paljenja** : **UKLJU ENA** kada je radi greja za paljenje.
8. **Svetle a dioda Drvo** : **UKLJU ENA** kada kotao radi u modu na vrsto gorivo.
9. **Svetle a dioda Recept 1** : **UKLJU ENA** kada je izabran Recept 1.
10. **Svetle a dioda Recept 2** : **UKLJU ENA** kada je izabran Recept 2.
11. **Svetle a dioda Chrono** : **UKLJU ENA** kada je ulaz **Chrono** zatvoren

8.1.3 Displej

Displej\Režim\Alarmi\Temperatura: etrvoro cifreni/slovni Displej prikazuje temperaturu vode u kotlu, radni režim i eventualne alarme

Prikaz	Opis	Prikaz	Opis
OFF	Isklju en (OFF)	Mod	Modulacija
Chc	Provera	MRn	Mirovanje
Acc	Paljenje	Sic	Sigurnosni režim
Stb	Stabilizacija	SPE	Gašenje
rEc	Ponovno paljenje	ALt	Isklju en sistem sa Alarmima

Prikaz	Opis	Prikaz	Opis
	Otvoren je priključak sigurnosnog termostata – tastera za ručno resetovanje		Slučajno gašenje
	Sigurnosni režim		Očitavanje sonde van opsega
	Ne uspelo paljenje		

NAPOMENA:

- Uključivanje Termoleguratora putem Glavnog prekidača, Kod proizvoda i Verzija firmiera su prikazane u dužini od 2 sekunde.

Prikaz	Opis	Prikaz	Opis
	Kod proizvoda		Verzija programa

8.2 Start rada kotla na biomasu

- Kotao priključen na hidraulički sistem.
- Izbušiti otvor prenika 4 mm na gornjoj strani dimne cevi u zoni koja je veoma blizu dimnog izlaza kotla. (slika 12.)

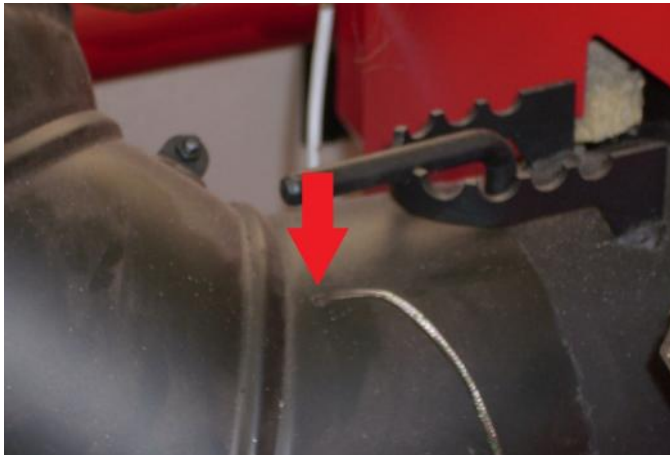

Slika 12. Postavljanje sonde

- Uveriti se da je mehanizam za transport peleta vrsto oslonjen na pod, da je klapna ventilatora maksimalno otvorena i da je voćica klapne za sigurnosni vazduh od 15 do 20 mm. (slika 13. i 14.)



Slika 13. Položaj klapne ventilatora



Slika 14. Položaj max. otvorene klapne vent.

- Klapnu za potpalu otvoriti, tj. ručicu ove klapne koja se nalazi bočno na kotlu gurnuti ka dimnom izlazu. (slika 15.)



Slika 15. Položaj ručice klapne POTPALA

- Utičnicu na zadnjoj strani kotla spojiti sa glavnim mrežnim napajanjem.
- Sipati manju količinu peleta u silos i zatvoriti ga.
- Pre same faze potpale, rešetke rosta skinuti sa nosača. Rešetke postaviti samo kada se kotlovi koriste na drvo.
- U ovoj fazi potrebno je ubaciti pelet u komoru za sagorevanje i to radom transportnog mehanizma za pelet (pellet feeding system). Na taj način postićemo kontinualno raspoređivanje peleta od komore za sagorevanje pa do silosa. Do pokretanja mehanizma za pelet može doći i samo u fazi rada kada na displeju piše „OFF“. Tada pritiskom na komandno dugme 2 koje u svom donjem delu ima simbol za pužni transporter, dolazi do

pokretanja mehanizma. Sve dok držimo dugme pritisnuto mehanizam radi. Kada dugme pustimo mehanizam stane.

Nalaganje komore peletom tzv. ručnom komandom vršiti nešto niže do početka delova od sivog liva, što je prikazano **slikom 16**.



Slika 16. Prikaz nivoa peleta

- Sada kada imamo pelet u komori za sagorevanje i kada je on u zoni grejanja za potpalu, možemo da startujemo po etak rada kotla. Start se izvodi tako što pritisnemo i držimo komandno dugme 4 više od 3 sekunde. Na donjem delu ovog dugmeta prikazan je i simbol za rastresit materijal, odnosno pelet. U trenutku kada kotao krene u potpalu na displeju piše Chc i u ovih nekoliko sekundi radi samo ventilator. Za vreme ove faze automatika proverava da li su svi uređaji neophodni za rad zaista i priključeni. Sledeći korak je kada na displeju piše Acc. Ovo je oznaka faze paljenja. Tada se osim ventilatora pali i grejanje za potpalu što se vidi i na automatici jer sijaju signalne lampice sa brojevima 2 i 7. U fazi potpale u jednom trenutku treba otkivati da se uključi i sistem za transport i da se nivo peleta u komori dopuni. Idealno je da kad posle ove dopune pelet bude do samog početka delova od sivog liva. Kotao je u fazi potpale sve dok dimni gasovi ne pređu temperaturu koja je određena parametrom **F18**. Prema fabričkim podešavanjima ova temperatura je **50°**. Prvo se pojavi dim a u periodu od 7 do 10 minuta i plamen.
- Kada dimni gasovi pređu granicu temperature paljenja na displeju se pokazuje natpis Stb. Ovo znači da je kotao u fazi stabilizacije plamena tj. sada automatika meri da li dimni gasovi imaju dovoljan prirast za određeno vreme. Ventilator radi prema parametru za fazu stabilizacije, a i dolazi do dopune ložišta peletom takođe prema parametrima puža u fazi stabilizacije. U trenutku kada je i ovaj faktor zadovoljen kotao ide u radni režim.

- Kotao je u radnom režimu kada na displeju ne piše ništa osim trenutne temperature vode u kotlu. Treba sačekati od 20 do 30 minuta i videti da li pelet gori na vrhu komore za sagoravanje. Takođe u ovom periodu treba pratiti i kolika je temperatura dimnih gasova. To se radi tako što se kratko pritisne komandno dugme 1 pa dugme 3 i na kraju dugme 2. Na displeju je tada broj koji označava temperaturu dimnih gasova. Kada ova vrednost bude blizu 200 stepeni ili neznatno preko treba zatvoriti klapnu koja je na bočnoj strani kotla **slika 17**.



Slika 17. Položaj ručice klapne RADNI

! NAPOMENA: Ovo su izmerene vrednosti tokom sertifikovanja.

- Na automatiku može biti povezan sobni termostat. U ovom slučaju, važno je podesiti temperaturu prostorije koja je glavni parametar za rad kotla i temperaturu vode u kotlu (70°C). Kada je aktiviran rad sobnog termostata, kotao najpre ima zahtev za postizanjem temperature sobe, stoga je ograničen zadatom temperaturom vode u njemu. Postoji mogućnost da kotao prestane sa radom pre zadate temperature sobnog termostata, u ovom slučaju treba podići i zadatu temperaturu vode u kotlu npr. 70°C.
- Sagorevanje peleta, bez obzira na snagu sa kojom kotao radi, neophodno je podesiti tako da je na vrhu prostora za sagorevanje (**prikazano na slici**). Ovo se postiže podešavanjem doziranja peleta i količine vazduha. U slučaju da nivo plamena počinje da se spušta, neophodno je da se produži vreme doziranja ili smanjenje količine vazduha. Ako želimo da smanjimo toplotnu moć, neophodno je da smanjimo količinu vazduha. Ako se desi da se nivo plamena podiže, možemo da smanjimo vreme nalaganja ili povećamo količinu vazduha. Za ta određivanja parametara potrebno je pratiti proces rada najmanje sat vremena.

NAPOMENA: Uvek se treba pridržavati nominalne ili maksimalne snage sagorevanja peleta, tj. kada pelet sagoreva na vrhu gorionika. U ovom slučaju smanjenje toplotne moći vršimo smanjenjem zadate temperature vode u kotlu ili zadate temperature sobnog termostata.

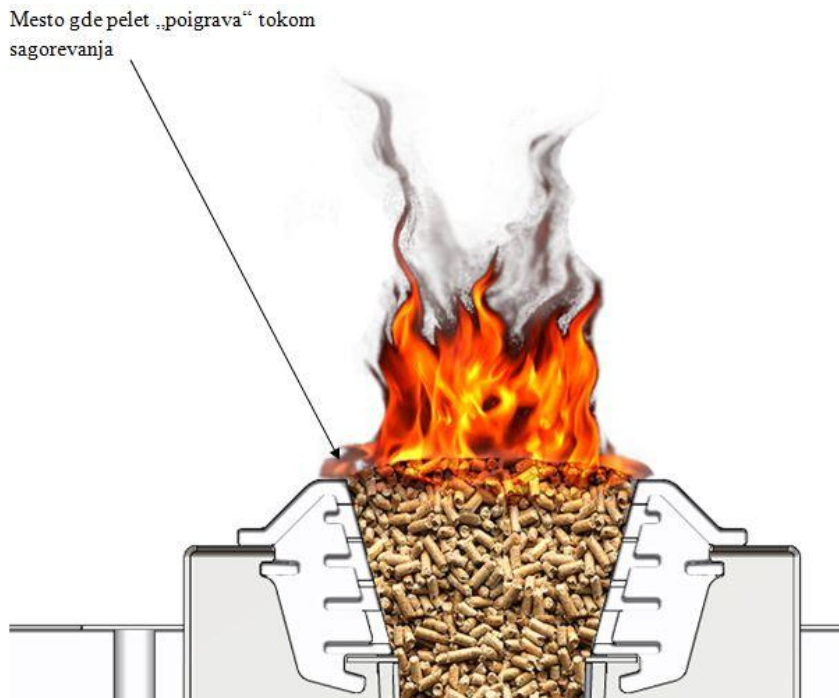

Upozorenje: Obavezno izvršiti analizu dimnih gasova nakon završetka instalacije kotla. Izmeriti procenat kiseonika (O₂).

8.3 Start rada kotla na vrsto gorivo

U slučaju da korisnik želi rad kotla na vrsto gorivo treba odraditi sledeće korake:

- Pre same upotrebe kotla na drvo postaviti rešetke rosta.
- Ako kotao nikad ranije nije korišćen na pelet već se prvi put koristi na vrsto gorivo onda je potrebno neku malu količinu peleta povući do komore za sagorevanje. Na ovaj način se sprečava tzv. falš vazduh kroz kanale dozatora.
- Kroz donja vrata pripremiti malu količinu drveta i potpaliti. Posle dobijanja većeg plamena dodati gorivo. Radi manje količine dima otvoriti klapnu unutar kotla i to tako što ručicu koja je na bočnoj strani kotla gurnemo ka dimnjaku tj. u položaj otvoreno.
- Obratiti pažnju na signalne lampice broj 6 i broj 7. Ako je upaljena lampica 6 to znači da je kotao u radnom režimu Pellet. Tada treba držati pritisnuto komandno dugme 4 i to više od 3 sekunde. Na taj način gasimo režim Pellet. Odmah nakon toga pritisnuti komandno dugme 3 i držati više od 3 sekunde. Na taj način startujemo režim rada Drvo.
- Posle 20 do 30 minuta kada je kotao krenuo u normalni radni režim klapnu unutar kotla vratiti u radni režim i to tako što ručicu sa bočne strane gurnemo ka prednjim vratima kotla.
- Prostor za sagorevanje peleta **nikako ne prekrivati** kutijama za pepeo i slično, jer se kroz taj prostor dobija vazduh potreban za sagorevanje drveta ili uglja.

8.4 Kratko uputstvo za upotrebu automatike

8.4.1 DOPUNA LOŽIŠTA SA PELETOM, PRIPREMA ZA PALJENJE

- Sipati pelet u silos
- Na glavnom displeju more da piše **OFF**



- Pritisnuti i držati dugme . Sve dok držimo dugme transporter radi i na displeju piše **LOAD PELET**.

8.4.2 START POTPALE NA PELET, PREKIDA RADA NA PELET

- Uključiti glavni prekidač



- Pritisnuti dugme  i držati 4-5 sekundi.



- Prekid rada kotla na pelet vrši se pritiskom na dugme  i držanjem 4-5 sekundi.



8.4.3 PROMENA VREMENA DOZIRANJA TRANSPORTERA U RADNOM REŽIMU



- Pritisnuti jednom kratko .



Ako lampica 1 pored samog simbola za puž blinka pritisnuti ,

sa  i  promeniti vrednosti doziranja puža na željenu I ponovo pritisnuti

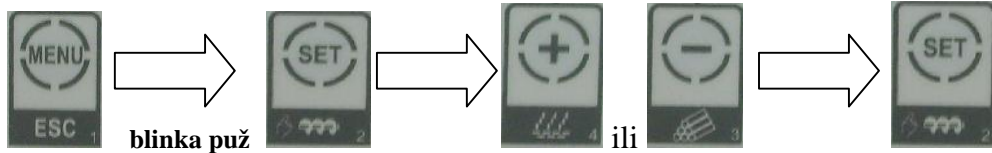

8.4.4 PROMENA JAŠINE VENTILATORA U RADNOM REŽIMU.

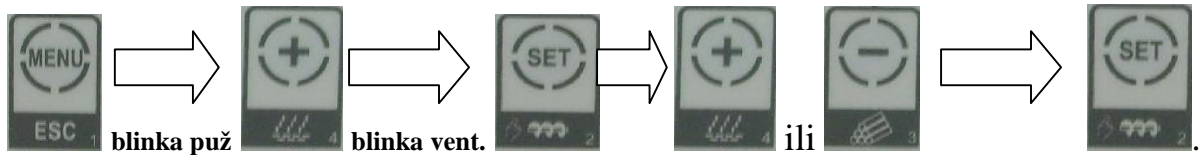

8.4.5 PROMENA ZADATE TEMPERATURE VODE U KOTLU.

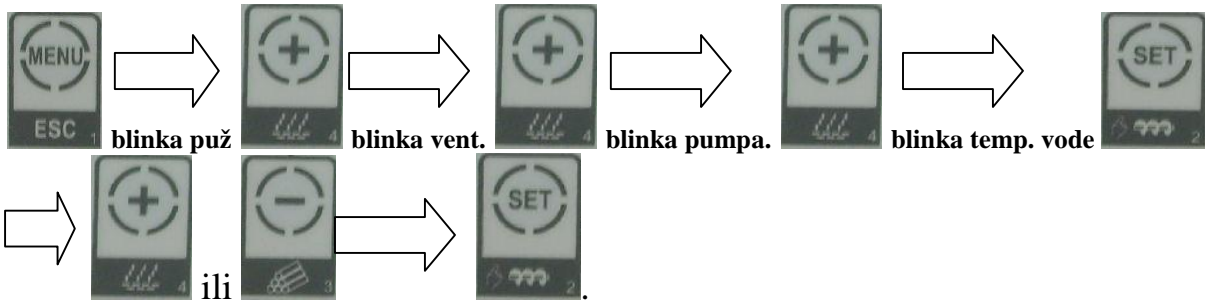

8.4.6 PROMENA NAŠINA POTPALE RUŠNO ILI AUTOMATSKI.

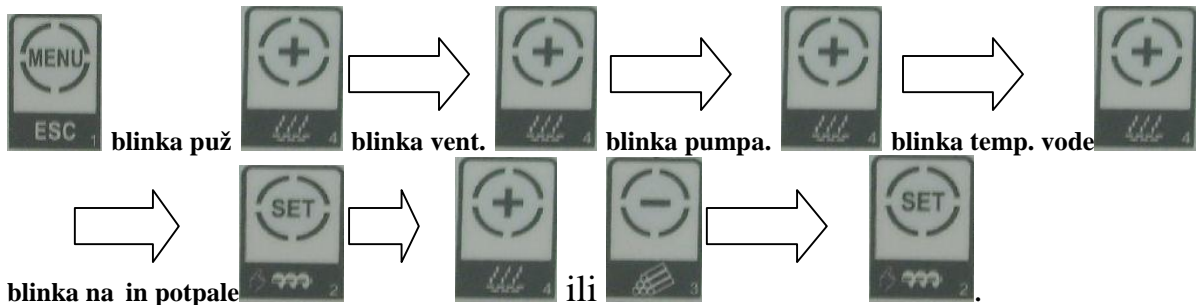

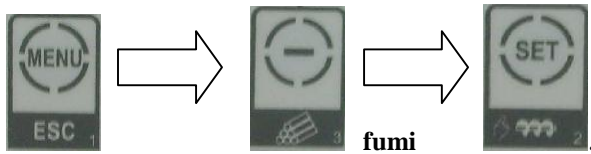

8.4.7 KAKO Očitati TEMPERATURU DIMOVODNIH GASOVA.



8.4.8 ULAZAK U SKRIVENI MENI.



Pritisnuti  i držati, odmah zatim pritisnuti  i držati oba dugmeta 5 sekundi. Odmah po ulasku u skriveni MENI na displeju piše **CL 00**. To je prvi parametar.



8.5 Greške prilikom startovanja kotla

Sve moguće greške u početnoj fazi rada tj. prilikom potpale mogu da se podele u tri velike grupe:

- **Grupa I**. Greške u potpali koje se odnose na situaciju kada nema pojave varnica, dima ni bilo kakvog plamena više od 20 minuta od trenutka kada se upalio grejač za potpalu.
- **Grupa II**. Greške u potpali koje se odnose na situaciju kada je došlo do pojave plamena ali se kotao posle izvesnog vremena (nekoliko minuta) ipak ugasio.
- **Grupa III**. Kotao je uspešno potpalio i radio nekoliko sati. Dostigao je zadatu temperaturu i duže vremena nema potrebe da se uključi ni dozirni sistem ni ventilator (najčešće je ova situacija tokom noći). Zatim temperatura pada ili korisnik želi višu temp. (najčešće ujutru) i kotao dobija signal da krene u fazu potpale, ali do plamena ne dolazi.

Grupa I

Mogući **uzrok 1**.

- **PROBLEM 1** – Zatvorena klapna ventilatora za primarni vazduh. Ventilator se nalazi na dozatoru.
- Postupak za rešavanje **PROBLEMA 1** – Otvoriti klapnu ventilatora maksimalno

Mogući **uzrok 2**.

- **PROBLEM 2** – Crevo koje spaja kanal vazduha od ventilatora do grejača nije pravilno postavljeno.

- Postupak za rešavanje **PROBLEMA 2** – Pri vrstiti crevo za vazduh i na ku ište greja a i na cev kanala za vazduh

Mogu **uzrok 3**

- **PROBLEM 3** – Prostor izme u greja a i cevnog ku išta u kome je zavijen greja je zapušen sa katranom i pepelom tako da nema prodora vazduha.
- Postupak za rešavanje **PROBLEMA 3** – O istiti ovaj prostor i to prvo probati samo sa strane unutar ložišta žicom debljine 1-2mm. Ako ovo ne uspe islju iti kotao iz struje, odviti greja i sada o istiti prostor u kome je smešten.

Mogu **uzrok 4**

- **PROBLEM 4** – Prostor u dubini ložišta gde sagoreva pelet je pun nesagorelih ostataka odnosno šljake tako da nema dodira peleta i vrelog vazduha.
- Postupak za rešavanje **PROBLEMA 4** – O istiti dubinu ložišta i to prvo krupniju šljaku mehani ki a sitniju je mogu e pokupiti i usisiva em.

Mogu **uzrok 5**

- **PROBLEM 5** – Pelet koji se koristi je velike vlažnosti.
- Postupak za rešavanje **PROBLEMA 5** – Probati sa peletom koji je ve eg stepena suvo e.

Mogu **uzrok 6**

- **PROBLEM 6** – Mrežni napon na koji je priklju en kotao je znatno manji od 220-230V tako da je i snaga greja a manja.
- Postupak za rešavanje **PROBLEMA 6** – Priklju iti mrežni ispravlja napona ili potpaliti ru no.

Mogu **uzrok 7**

- **PROBLEM 7** – Posle ru nog nalaganja i automatske dopune ložišta u fazi potpale nivo peleta je takav da pelet nije u kontaktu sa greja em.
- Postupak za rešavanje **PROBLEMA 7** – Dopuniti nivo peleta.

Mogu **uzrok 8**

- **PROBLEM 8** – Preba en je kotao iz automatskog u ru ni režim rada. Ako tokom itave faze potpale ne gori lampica za greja onda smo sigurni da je kotao u ru nom režimu.
- Postupak za rešavanje **PROBLEMA 8** – Prebaciti kotao u automatski režim potpale.

Mogu **uzrok 9**

- **PROBLEM 9** – Neispravan elektro greja za potpalu. Isključiti kotao iz mrežnog napajanja i na priključnim kablovima elektro greja izmeriti omsku otpornost.
- Postupak za rešavanje **PROBLEMA 9** – Promeniti elektro greja

Grupa II

Mogu **uzrok 1.**

- **PROBLEM 1** – Zatvorena je klapna u kotlu kojom se rukuje sa ručicom koja je na bočnoj strani. Pojavljuje se mnogo dima a dimni gasovi nemaju dovoljno brz porast tako da kotao ide u gašenje.
- Postupak za rešavanje **PROBLEMA 1** – Otvoriti klapnu, tj gurnuti ručicu ka dimnjaku

Mogu **uzrok 2.**

- **PROBLEM 2** – Brzina ventilatora u fazi potpale. Brzina ventilatora za primarni vazduh u ovoj fazi je određena parametrima Uc00 i Uc01. Ukoliko je brzina drastično promenjena u odnosu na fabrički podešenu nije dobro ni značajno je smanjiti ni povećati. U slučaju kad je ventilator u potpali slab onda nema porasta temp. dimnih gasova a ako je prejak može doći do brze potrošnje peleta u komori što opet dovodi do smanjenja temp. dimnih gasova u potpali.
- Postupak za rešavanje **PROBLEMA 2** – Podesiti vrednosti parametara Uc00 i Uc01 na fabričke ili blizu fabričkih.

Mogu **uzrok 3**

- **PROBLEM 3** – Brzina ventilatora u fazi stabilizacije plamena. Kotao u fazi potpale, pojavi se dim, na displeju piše Stb što znači da je u fazi stabilizacije plamena ali posle toga kotao se ugasi. Najčešće uzrok ovome je preslab ventilator u fazi stabilizacije što je određeno parametrom Uc04.
- Postupak za rešavanje **PROBLEMA 3** – Povećati brzinu ventilatora parametrom Uc04.

Mogu **uzrok 4**

- **PROBLEM 4** – Previše ili premalo peleta u fazi stabilizacije. Ako ima malo ili previše peleta dok na displeju piše Stb tj. stabilizacija, može doći do zagušenja plamena i vraćanja kotla u stanje gašenja. Količina peleta u fazi stabilizacije se reguliše parametrom CL04.
- Postupak za rešavanje **PROBLEMA 4** – vrednost parametra CL04 na fabričku ili blisku fabričkoj.

Mogu uzrok 5

- **PROBLEM 5** – Kotao je ušao u fazu stabilizacije ali ide u fazu gašenja jer nema dovoljan prirast temp. dimnih gasova. Naročito je stagnacija odnosno mali pad temp. dimnih gasova uočajljiv u trenutku kada kreće dopuna ložišta sa peletima.
- Postupak za rešavanje **PROBLEMA 5** – Podiži temp. dimnih gasova za ulazak sistema u Fire ON a to je parametar F18. Na taj način novi pelet koji ulazi u komoru za sagorevanje teže obara temp. dimnih gasova jer je plamen jači iz razloga što mu se dalo više vremena do trenutka dopunjavanja. Ovaj problem se najčešće javlja kad su slabi dimnjaci ili je vuha dimnjaka iz nekog drugog razloga slaba.

Mogu uzrok 6

- **PROBLEM 6** – Kotao je prošao i fazu stabilizacije ali ide u modulaciju, na displeju piše Nod. Ako se provere dimni gasovi u tom se trenutku zapaža da su previsoki.
- Postupak za rešavanje **PROBLEMA 6** – Proveriti da li je klapna unutar kotla u položaju „otvoreno”. Zatvoriti klapnu tj. pomeriti ručicu na bočnoj strani kotla ka prednjoj strani.

Mogu uzrok 7

- **PROBLEM 7** – Kotao je ušao u fazu stabilizacije ali posle izvesnog vremena ide u gašenje.
- Postupak za rešavanje **PROBLEMA 7** – Zaboravljena da se vrati u kotao ili potpuno zatvori fioka za pepeo.

Grupa III

Uvod

Kada kotao dostigne zadatu temperaturu vode u njemu ili vazduha u prostoriji gde je sobni termostat, prelazi u fazu mirovanja, odnosno održavanja plamena ili u originalu Standby fazu. Najbolji primer za ovakav način rada kotla je noćni rad.

Osnovni cilj ove faze je održati plamen odnosno žar u ložištu tokom višesatnog mirovanja. To se postiže periodičnim uključivanjem i pelet transportera i ventilatora u određenim periodima vremena.

- U trenutku kada je kotao dostigao zadatu temperaturu on ulazi u fazu održavanja plamena. Posle određenog perioda vremena, što je određen parametrom t04 (u minutima) transporter kreće u rad i ventilatori se aktiviraju. U ovim periodima dolazi do aktiviranja kotla sve dok ne dobije komandu za start zbog postizanja zadate temperature.
- Vreme trajanja jednog procesa rada transportera i ventilatora određen je parametrom t05 (u sekundama).
- Tokom samog procesa uključivanja transportera njegov rad je određen aktivnim, radnim periodom što je određen parametrom CL09 (u sekundama) ali i periodom pauze što je određen parametrom CP09 (u sekundama).

- Za vreme procesa održavanja plamena ventilator za primarno sagorevanje se uključuje sa snagom koja je određena parametrom Uc09.

Moguće greške u radu vezane za fazu održavanja plamena:

- Kotao i pored funkcionisanja faze održavanja plamena nema dovoljno peleta za start i rad u normalnom režimu.
- Otklanjanje uzroka greške :
 1. Smanjiti parametar t04, odnosno povećati učestanost rada transportera i ventilatora u fazi mirovanja.
 2. Povećati vreme trajanja procesa tj. parametar t05.
- Previše nesagorelog peleta pri kretanju kotla u rad.
- Otklanjanje uzroka greške :
 1. Povećati parametar t04
 2. Smanjiti parametar t05
 3. Smanjiti snagu ventilatora za primarno sagorevanje u fazi održavanja plamena parametar Uc09.

8.6 Održavanje kotla TKAN

Kotao TKAN zahteva svakodnevno i periodično održavanje.

- Svakodnevno održavanje se odnosi i na prostor samog ložišta od sivog liva gde stalnim izbacivanjem pepela omogućavamo bolji rad elektro grejača za potpalu i bolje sagorevanje tj. veći protok vazduha kroz vazdušne kanale u sivom livu. Takođe se pepeo veći u toku dana počinje da se taloži na podu, prostoru oko samog ložišta. Pri prosečnim parametrima sagorevanja 100kg peleta proizvede 1kg pepela.
- Na svakih 3 do 7 dana potrebno je očistiti prostor oko segmenata sivog liva za sagorevanje peleta (**slika 18.**). Takođe je potrebno očistiti naslage na zidovima samog ložišta. Ovim dobijamo bolji stepen prenosa jer jedan milimetar naslaga katrana i prašine smanjuje provodnost za 5%.
- Jednom u mesec dana potrebno je otvoriti i gornji poklopac za održavanje koji je preoznačen dimenzije 372mm x 285mm za TKAN 1.1 i TKAN 1.2 i 492mm x 285mm za TKAN 2, izvaditi turbulatore i sa celog tada dostupnog dela kotla skinuti katran i prašinu (**slika 18.**). Sve što se tada skinje pokupi se kroz donje otvore, odn. kroz pepeljaru ložišta.

Ukoliko u kotlu, tokom korišćenja javi kondenzacija, potrebno je pokupiti kondenzat i ceo kotao iznutra premazati baznim sredstvima za održavanje ili barem vodenim rastvorom građevinskog krečnina. Na taj način se vrši neutralizacija kiselina usled kondenzacije.

 **Pri održavanju i servisiranju kotla, kotao isključiti sa napajanja.**

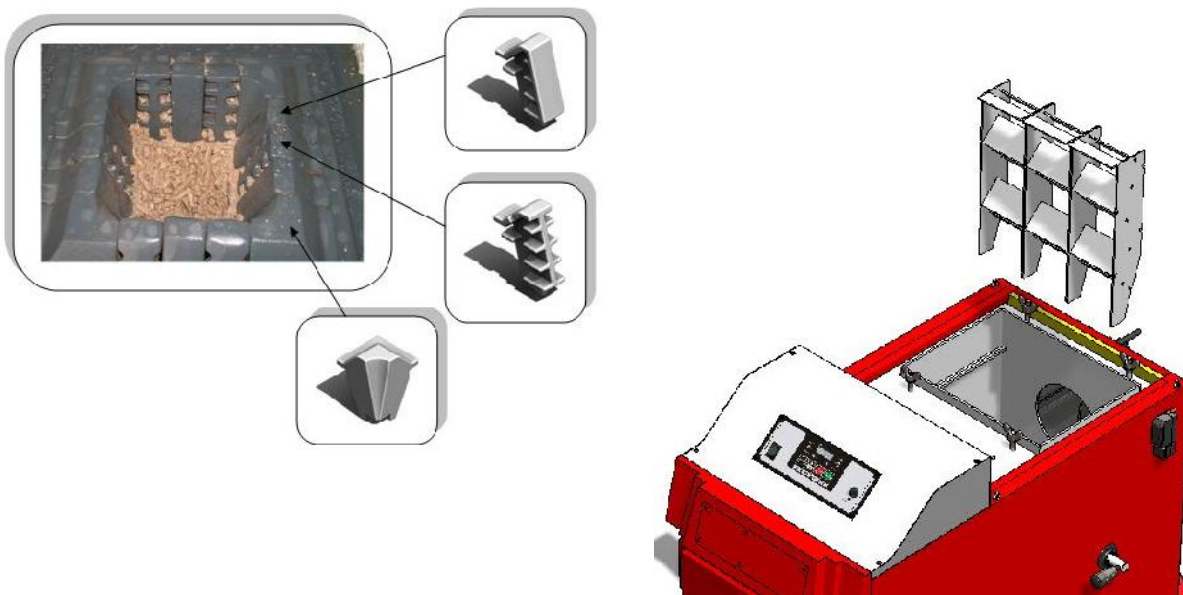

Slika 18. Prikaz uklanjanja turbulatora iz kotla TKAN i demontaža livenih segmenata ložišta

 ***Na ovaj način obavezno konzervirati kotao na kraju grejne sezone. U toj situaciji zatvoriti i sve otvore na kotlu da ne dodje do cirkulacije vazduha kroz kotao jer i tako može doći do pojave vlage u kotlu.***

 **Održavanje kotla je jedan od najbitnijih faktora za dužinu radnog veka kotla. Naročito je bitno da u vansezoni kotao bude očišćen i da se izvrši *eutralizacija* kiseline na koje je opisan na in.**

8.7 Natpisna plo ica

Natpisna plo ica je nalepljena na dobro vidljivo mesto na kotlu i sadrži slede e (videti sliku u ta ki NALEPNICE):

1. Tehni ki podaci sa nalepnice:

- Proizvo a (Radijator inženjering)
- Serijski broj kotla (primer: N°:100914118)
- Godina proizvodnje (primer: 2014)
- Tip kotla (TKAN 1.1,TKAN 1.2 ili TKAN 2)
- Nazivna toplotna snaga kotla (TKAN 1.1 – 27 ili TKAN1.2 -34.9kW ili TKAN 2 – 49,5kW)
- Podru ije upotrebe toplotne snage (TKAN 1.1 – 8,1–27kW ili TKAN 1.2 – 8.1-34.9kW ili TKAN 2 – 14,5-49,5kW)
- Potrebna promaja dimnjaka (18Pa)
- Elektri ni napon (230V)
- Frekvencija (50Hz)
- Ja ina struje (3,35A)
- Nazivna el. snaga (570W)
- Maksimalna dodatna el. snaga (200W)
- Ukupna el.snaga (635W)
- Težina (TKAN 1.1 – 635kg ili TKAN 1.2 – 635kg ili TKAN 2 – 787kg)
- Klasa kotla po EN 303-5 (5)
- Maksimalni pritisak (3 bar)
- Maksimalna temperatura (90°C)
- Koli ina vode izražena u litrima (TKAN 1.1 – 97L ili TKAN 1.1 – 97L ili TKAN 2 – 125L)
- Oznaka tipa goriva – pelet C1

2. Nalepnica uvoznika

3. OEEO

4. Ostale oznake na kotlu



8.8 Izjave



IZJAVA O USAGLAŠENOSTI

U skladu sa direktivom 2006/42/EC o mašinama
Prilog II, deo 1, odeljak A

U ime: "RADIJATOR Inženjering-a" d.o.o. /Živojina Lazića Solunca 6, 36000 Kraljevo, Srbija

IZJAVLJUJE

S potpunom odgovornošću da:

Grejni kotlovi na drvo/pelet serije TKAN nominalne toplotne snage:
TKAN 1.1 -27kW i TKAN 1.2 -34.9kW i TKAN 2 -49.5kW

ispunjavaju zahteve: Direktive 2006/42/EC o mašinama (stupila na snagu 29/06/2006),

i zahteve sledećih direktiva i propisa:

1. Direktive 2004/108/EC Evropskog Parlamenta i Saveta od 5. Decembra 2004 o približavanju zakonodavstava država članica u vezi elektromagnetne kompatibilnosti (tekst značajan za EEP) i stavljanja van snage Direktive 89/336/EEC;
2. Direktive 2006/95/EC Evropskog Parlamenta i Saveta od 12. Decembra 2006 o usklađivanju zakonodavstava država članica u vezi električne opreme namenjene za upotrebu u okviru određenih granica napona (kodifikovana verzija) (tekst značajan za EEP) i stavljanja van snage direktive 73/23/EEC.

Uređaj je usaglašen sa sledećim EN standardom:
EN 303-5:2012,

i sledećim EN i tehničkim zahtevima: EN 60730-1.

ISPITIVANJE TIPRA KOTLA TUV Rheinland/ Paluska Gyula/ H/B1 12 0485.

Mesto: Kraljevo
Datum: 2014-02-07

Potpis: 
Milan Janić, generalni direktor

8.7 Nalepnica

Na kotlu TKAN nalaze se nalepnice za označavanje priključaka kao i nalepnice za opasnost od strujnog udara, nalepnice za šemu povezivanja i dr.

Nalepnice koje označavaju priključke za povezivanje instalacije:

1. Nalepnica (Potisni vod) 32mm x 74mm



2. Nalepnica (Povratni vod) 32mm x 74mm



3. Nalepnica (Sigurnosna grupa) 32mm x 74mm

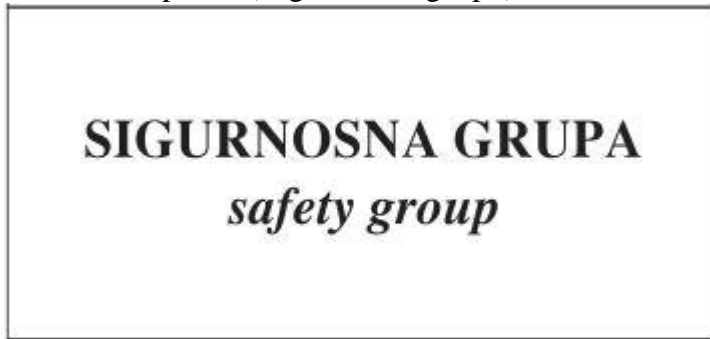

4. Nalepnica (Punjenje/pražnjenje) 32mm x 74mm

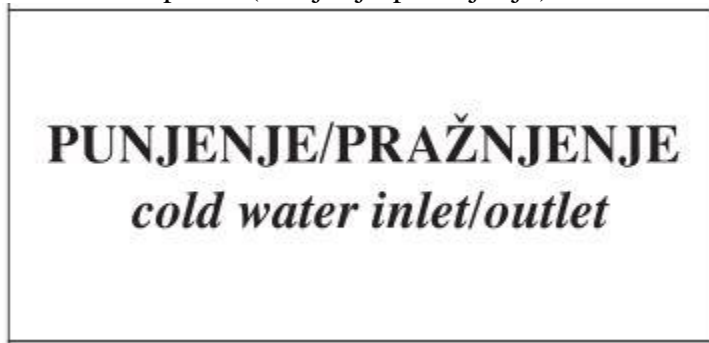

5. Nalepnica (Izmenjiva termi kog osiguranja) 32mm x 74mm



6. Nalepnica (Sonda termi kog osiguranja) 32mm x 74mm



7. Nalepnica (Šema povezivanja) 152mm x 210mm

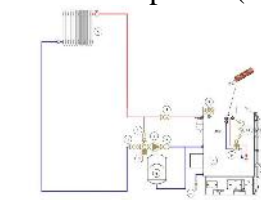

- Šema povezivanja:
Legenda:
1. Izvor napajanja
2. Ventil
3. Sonda
4. Relaj
5. Kontrolna ploča
6. Elektromagnet
7. Pritisnik
8. Ventil osiguranja pritiska
9. Ventil osiguranja pritiska
10. Ventil osiguranja pritiska
11. Ventil osiguranja pritiska

Nalepnice koje označavaju prisustvo struje, visokog napona i opasnosti:

1. Nalepnica (Napon opasan po život) 60mm x 80mm



2. Nalepnica (Ulaz za sniženim naponom 12V) 60mm x 80mm



3. Nalepnica (Napon opasan po život - VE A) 100mm x 150mm



4. Nalepnica (Uzemljenje) 20mm x 30mm



5. Nalepnica (Prisustvo napona)



Nalepnice koje označavaju upozorenje:

1. Nalepnica (Izloženi pokretni delovi mogu izazvati povrede) 30mm x 80mm



2. Nalepnica (Obavezno poštovanje u rad od strane ovlašćenog servisa)
65mm x 247mm



3. Nalepnica (Pažnja)



4. Nalepnica (Otpad)



Nalepnice sa tehni kim podacima:

Živjina Lazića Solunca br.6
Grdica-36000 Kraljevo
Srbija

N^o 100815092
TKAN 1.1



Živjina Lazića Solunca br.6
Grdica-36000 Kraljevo
Srbija

N^o 100815092
TKAN 1.2

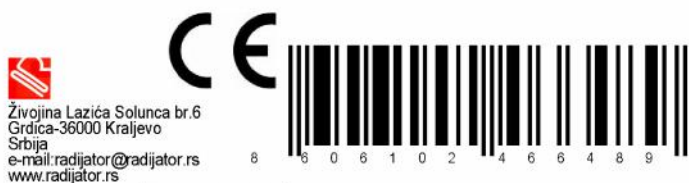

Živjina Lazića Solunca br.6
Grdica-36000 Kraljevo
Srbija
e-mail: radijator@radijator.rs
www.radijator.rs

Pressure max	Temp. max
Max. pritisak	Max. temp.
3 bar/300kPa	90°C

N^o: 100815092
Godina/Year: 2015

PROIZVOĐAČ MANUFACTURER	Radijator Inženjering
TIP - MODEL TYPE - MODEL	TKAN 1.1
NAZIVNA TOPLOTNA SNAGA KOTLA NOMINAL HEAT OUTPUT POWER	27 kW
PODRUČJE UPOTREBE TOPLOTNE SNAGE HEAT OUTPUT RANGE	8.1 - 27 kW
POTREBNA PROMAJA DIMNJAKA REQUIREMENT AIR FLUE	18Pa
ELEKTRIČNI NAPON VOLTAGE	230 V
FREKVENCIJA FREQUENCY	50 Hz
JACINA STRUJE CURRENT	3.35 A
NAZIVNA EL. SNAGA NOMINAL ELECTRICAL POWER	570 W
MAX. DODATNA EL. SNAGA MAX. EXTENDED EL. POWER	200 W
UKUPNA EL. SNAGA ALL EL. POWER	770 W
MASA KOTLA MASS OF BOILER	635 Kg
ZAPREMINA VODE U KOTLU VOLUME OF WATER IN THE BOILER	97 L
KLASA KOTLA PO EN 303-5:2012 CLASS OF BOILER ACCORDING TO EN 303-5:2012	5
GORIVO FUEL	C1

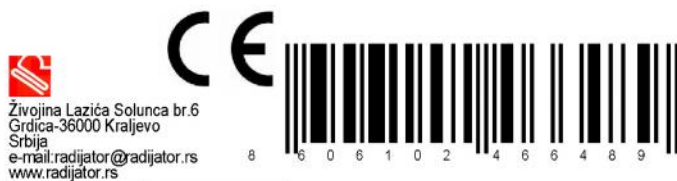

Živjina Lazića Solunca br.6
Grdica-36000 Kraljevo
Srbija
e-mail: radijator@radijator.rs
www.radijator.rs

Pressure max	Temp. max
Max. pritisak	Max. temp.
3 bar/300kPa	90°C

N^o: 100815092
Godina/Year: 2015

PROIZVOĐAČ MANUFACTURER	Radijator Inženjering
TIP - MODEL TYPE - MODEL	TKAN 1.2
NAZIVNA TOPLOTNA SNAGA KOTLA NOMINAL HEAT OUTPUT POWER	34.9 kW
PODRUČJE UPOTREBE TOPLOTNE SNAGE HEAT OUTPUT RANGE	8.1 - 34.9 kW
POTREBNA PROMAJA DIMNJAKA REQUIREMENT AIR FLUE	18Pa
ELEKTRIČNI NAPON VOLTAGE	230 V
FREKVENCIJA FREQUENCY	50 Hz
JACINA STRUJE CURRENT	3.35 A
NAZIVNA EL. SNAGA NOMINAL ELECTRICAL POWER	570 W
MAX. DODATNA EL. SNAGA MAX. EXTENDED EL. POWER	200 W
UKUPNA EL. SNAGA ALL EL. POWER	770 W
MASA KOTLA MASS OF BOILER	635 Kg
ZAPREMINA VODE U KOTLU VOLUME OF WATER IN THE BOILER	97 L
KLASA KOTLA PO EN 303-5:2012 CLASS OF BOILER ACCORDING TO EN 303-5:2012	5
GORIVO FUEL	C1

8.8 Proizvođa

RADIJATOR D.O.O.
Živojina Lazića Solunca br.6
36000 Kraljevo, Srbija

Živojina Lazića Solunca br.6
Grdica-36000 Kraljevo
Srbija

N^o 100815097
TKAN 2



Živojina Lazića Solunca br.6
Grdica-36000 Kraljevo
Srbija
e-mail: radijator@radijator.rs
www.radijator.rs



Pressure max	Temp. max
Max. pritisak	Max. temp.
3 bar/300kPa	90°C

N^o: 100815097

Godina/Year: 2015

PROIZVOĐAČ MANUFACTURER	Radijator Inženjering
TIP - MODEL TYPE - MODEL	TKAN 2
NAZIVNA TOPLOTNA SNAGA KOTLA NOMINAL HEAT OUTPUT POWER	49.5 kW
PODRUČJE UPOTREBE TOPLOTNE SNAGE HEAT OUTPUT RANGE	14.5-49.5 kW
POTREBNA PROMAJA DIMNJAKA REQUIREMENT AIR FLUE	18 Pa
ELEKTRIČNI NAPON VOLTAGE	230 V
FREKVENCIJA FREQUENCY	50 Hz
JACINA STRUJE CURRENT	3.35 A
NAZIVNA EL. SNAGA NOMINAL ELECTRICAL POWER	570 W
MAX. DODATNA EL. SNAGA MAX. EXTENDED EL. POWER	200 W
UKUPNA EL. SNAGA ALL EL. POWER	770 W
MASA KOTLA MASS OF BOILER	787 Kg
ZAPREMINA VODE U KOTLU VOLUME OF WATER IN THE BOILER	125 L
KLASA KOTLA PO EN 303-5:2012 CLASS OF BOILER ACCORDING TO EN 303-5:2012	5
GORIVO FUEL	C1

36000 Kraljevo, Živojina Lazića - Solunca br.6, Srbija
tel. +381 36 399 140, fax. +381 36 399 150, <http://www.radijator.rs>
e-mail: radijator@radijator.rs

9. Garancija

1. Radijator inženjering pokriva različite garancijske periode za različite delove (što je navedeno u daljem tekstu) samo ako su ispunjeni sledeći uslovi garancije:

- 1.1. Kotao mora biti priključen po navedenim hidrauličkim šemama iz tehničkog uputstva, naročito obratiti pažnju na sigurnosne ventile, termičko osiguranje oticanjem, mešaju i ventil za zaštitu hladnog kraja kotla odnosno protiv kondenzacije, opseg radnog pritiska kotla, opseg radne temperature kotla, uslove u kotlarnici itd.
(videti tačku 7.)
- 1.2. Kotao mora biti priključen na dimnjak propisanog poprečnog preseka, karakteristika izolacije i visine. **(videti tačku 3.4)**
- 1.3. Dimovod od kotla do dimnjaka mora biti izveden po tehničkom uputstvu.
- 1.4. Kod kotla moraju biti izvršena i navedena elektro priključenja iz tehničkog uputstva, naročito se misli na karakteristike sobnog termostata, karakteristike mrežnog napona koji mora biti u određenim granicama.
- 1.5. Korisnik mora da se pridržava navedenih uputstava o korišćenju i održavanju.
(videti tačku 8.)

2. Garancijska izjava

Izjavljujemo:

- da proizvod ima propisana i deklarirana kvalitetna svojstva.
Obavezujemo se, da ćemo na zahtev kupca ako pravovremeno u garancijskom roku podnese zahtev za popravku, o svakom trošku izvršiti sve popravke kvarova, tako da će proizvod raditi u skladu sa deklariranim svojstvima,
- da će proizvod u garancijskom roku raditi besprekorno ako se budu poštovala uputstva za upotrebu, rad i montažu,
- da ćemo u garancijskom roku biti spremni da otklonimo sve kvarove na proizvodu i držati na zalihama sve potrebne rezervne delove,
- **garancijski rok počinje od DANA KUPOVINE I TRAJE 60 MESECI ILI 72 MESECA OD DATUMA PROIZVODNJE (datum proizvodnje nalazi se na nalepnici sa zadnje strane kotla),**
- **GARANCIJA OD 60 MESECI VAŽI SAMO AKO SE KOTAO REDOVNO SERVISIRA OD STRANE CENTRALNOG SERIVISA RADIJATOR INŽINJERINGA u periodu naznačenom za isti (dalje u tekstu),**
- **garancija važi ako je garantni list overen od strane prodavca i ako je upisan datum kupovine i priložen račun. TAKO JE BITNO JE IMATI I NALOG ZA PUŠTANJE U RAD. (overen od strane ovlašćenog servisa)**

3. Garancijski period od godinu dana važi za sledeće delove:

- Za sve ležajeve serije UCFL,
- elektro grejača za potpalu,
- Ležajeve elijastog sigurnosnog transportera (valvole),

4. Garancijski period od dve godine važi za sledeće delove:

- Motor reduktor,
- lance za prenos obrtnog momenta 083,
- donje pužne spirale,
- ventilator primarnog vazduha,
- ventilator sekundarnog vazduha,
- automatiku kotla sa sigurnosnim termostatom,
- sondu dimovodnih gasova,
- sondu temperature kotlovske vode.
- segmente za sagorevanje od sivog liva,
- elektro konektore,
- izolacijske materijale na vratima i otvorima za puštanje,
- delove elijastog sigurnosnog transportera (valvole) koji su od sivog i nodularnog liva.

5. Garancijski rok ne važi:

- ukoliko se posle svake grejne sezone ne odradi redovan servis,
- za zamenu delova kod redovnog godišnjeg održavanja u skladu sa uputstvima,
- kod kvarova koje je na inicijalno kupac zbog nestručnog rukovanja proizvodom,
- kod mehaničkih kvarova nastalih prilikom transporta i prilikom korišćenja (vrsti predmeti),
- ako je proizvod instaliran nestručno, suprotno važećim propisima iz tog područja,
- ukoliko se utvrdi da hidraulička šema nije urađena po preporukama firme „Radijator inženjering”,
- ako je kupac koristio proizvod iznad deklariranih svojstava i u normalnim okolnostima,

6. Garancijski rok prestaje da važi:

- ako se ustanovi da je kvarove otklanjala neovlašćena osoba ili neovlašćeni servis,
- ako kod popravke nisu bili upotrebljeni i ugrađeni originalni delovi,
- kad ističe garancijski rok.

7. Kod prijave kvarova obavezno je dati sledeće podatke:

- naziv i tip proizvoda,
- datum kupovine,
- fabrički ili radionički broj kamina,
- kratak opis kvara, odnosno nedostatka,
- tačnu adresu i kontakt telefon, mejl.

8. Redovan godišnji servis

Redovan servis se održava na kraju svake grejne sezone u period od 15.4. do 31.8. i naplaćuje se utvrđenim cenovnikom firme "Radijator Inženjering". Servisni postupak tehničkih lica koja obavljaju redovne godišnje servise, a koja su od strane proizvođača ovlašćena za to, obuhvataju sledeće operacije:



NAPOMENA: Serviser je dužan da pregleda sve navedene delove (sa liste) dozatora i izmenjivača, i ukoliko dođe do zamene bilo kojih delova na iste korisnik dobija gore navedenu garanciju kao i garanciju na još 12 meseci na telo kotla (izmenjivača). Garancija se može produžiti do 5 god. od datuma puštanja u rad. Servis i produženje servisa može da obavlja lice koje šalje centralni servis "Radijator inženjering"-a. Na nezamenjene delove posle održavanja servisa garancija ne važi.

- Demontaža silosa za pellet od pellet transportera;
- Demontaža pellet transportera od kotla;
- Skidanje oba lanca;
- Demontaža segmenata za sagorevanje od ložišta i čišćenje prostora ložišta ispod segmenata. Provera stanja segmenata i njihovog međusobnog zazora;
- Čišćenje prostora cevi ložišta u kojoj se okreće donja pužna spirala;
- Podmazivanje svih ležajeva gornje i donje pužne osovine i provera njihove ispravnosti. Ležaj ne sme da ima otežano okretanje ili naprsline na kućištu. U suprotnom ležaj se menja. Ukoliko se utvrdi da je do oštećenja ležaja došlo zbog upadanja vrstog predmeta u pelet transporter (zbog greške korisnika ili proizvođača peleta), Radijator inženjering naplaćuje vrednost ležaja. Ako je do oštećenja ležaja došlo zbog povlačenja plamena u sam pelet transporter i to iz razloga loše postavljenih parametara prilikom korišćenja, Radijator inženjering naplaćuje vrednost ležaja;
- Skidanje lanaca sa obe strane vratila elijastog sigurnosnog transportera (valvole) i provera ispravnosti ležajeva 6004 u valvoli. Ukoliko je okretanje ležajeva otežano, zameniti ležajeve sa obe strane. Ukoliko je do oštećenja ležaja valvole došlo zbog

upada vrstog tela koje nije iz samog kotla (zbog greške korisnika ili proizvođača peleta)
Radijator inženjering naplaćuje vrednost ležajeva;

- Proveriti oštrinu ivica rotora;
- Izvaditi sondu dimnih gasova i očitati je od naslaga;
- Provera ventilator;
- Provera dihtovanja gornjih i donjih vrata;
- Provera održavanja kotlovskog izmenjivača.

Contents:

1. Important warning;
 - 1.1 Minimum distance from flammable materials;
2. Description of the boiler;
3. Assembly;
 - 3.1 General warnings;
 - 3.2 Measures and safety devices for boilers TKAN;
 - 3.3 Boiler room;
 - 3.4 Connection to the chimney;
4. Cross-section of TKAN boiler with a description of the boiler elements;
5. Schematic connection of automation;
6. Table of technical data;
7. Hydraulic scheme;
8. Boiler operation and maintenance;
 - 8.1 Control panel;
 - 8.2 Operation start of the boiler operated by biomass;
 - 8.3 Start of work of boiler by solid fuel;
 - 8.4 Short manual for automatic control;
 - 8.5 Mistakes during ignition and start of the boiler;
 - 8.6 Maintenance of boiler;
 - 8.7 Nameplate;
 - 8.8 Declaration;
 - 8.9 Sticker;
 - 8.10 Manufactured;
9. Warranty.

1. Important warnings

GENERAL WARNINGS

- After the removing of the package check for the completeness of the delivery, in the case of defects, please contact the dealer who sold the boiler.
- The boiler must be used solely for the purpose envisaged by the manufacturer. Any liability of the manufacturer is excluded for damages to persons, animals or things, in case of errors during installation, regulation, maintenance or improper use.
- In case of leakage of water the device should be switched from the mains supply, close the water supply and inform the authorized service and authorized installers.
- This manual is an integral part of the device and must be kept with care and must always follow the device even in case of change of owner or user, or in case of connection to another installation. In case of damage or failure look for a new copy of an authorized dealer.



IMPORTANT WARNINGS

We emphasize that the use of the device working on bio-mass and solid fuel, having contact with electricity and water, demands respect and security measures such as:

- The use of the boiler by the children and people with limited capabilities without accompaniment is not allowed.
- It is forbidden to use boiler installations operating at temperatures higher than 110 ° C, and pressure greater than 3 bar.
- It is not allowed to use easily inflammable fuels (alcohol, oil) for faster wood ignition.
- It is forbidden to store easily flammable materials near the boiler and close the door for firing. The ashes must be disposed off in closed and non-flammable containers.
- It is prohibited to incinerate waste materials which cause combustion flame or explosion hazard (eg. plastic bags, sawdust, coal dust, mud, etc.).
- It is prohibited to any person or technical intervention or cleaning the boiler before it is switched off the main power supply switch, the setting on the device (0) "off".
- It is prohibited to change the safety elements.
- It is forbidden to close the vents in the room where the boiler is located. Air vents are needed for proper combustion.
- No exposure to atmospheric turbulents. The boiler is not designed for outdoor use and contains no anti-freeze system.
- It is forbidden to turn off the boiler when the outside temperature can drop below zero (to prevent freezing).
- Be aware of safety air valve position (detailed explanation in the chapter **OPERATION START OF BOILER**).

- In the case of intervention on any electrical device of boiler, switch off all the electrical wiring and so it is removed from the mains socket.
- Work with of boiler unit is forbidden for people with special needs (including children) to physical and mental health, except under the supervision of a guardian, and the people who are responsible for their behavior.
- Children must be supervised by a guardian as they do not play with the appliance boiler.
- If the damaged power protection, must be replaced in the factory and serviced by an authorized dealer or qualified people to avoid the risk of electric shock.

1.2 Minimum distance from flammable materials

- Provide adequate distance from flammable materials, if necessary to ensure the protection of the same.
- Minimum distance from flammable materials is required by law - please inquire of professionals who deal with heating and Emission effluents.
- The minimum distance of the boiler and flue pipe gas from the low and averagely combustible materials should be at least 100mm.
- Minimum distance from flammable materials is 200mm, and the same goes for materials whose flammability is not known.



Risk of fire!

- Storage of flammable materials and liquids in the vicinity of the boiler is prohibited.
- Be sure to warn users about the required minimum distance of combustible material from the boiler.

Combustibility of Construction materials	
A ... Noncombustible	asbestos, stone, building stone, ceramic wall tiles, terracotta, plaster, screed (without organic additives)
B... Non easily flammable	Gypsum cardboard slab, glass fiber slab of ACUMINE, ISOMINE, ROYALITE, LIGNOS, VELOX, HERACLITE
C1.. Low combustible	beech and oak wood, composite wood, file, slab of HOBREX, Versalite, umakart
C2 ... Averagely combustible	wood of pine, yew and pine, composite materials
C3... Easily combustible	Asphalt, paperboard, cellulose materials, chipboard, cork, polyurethane, polystyrene, polypropylene, polyethylene fiber floor

2. Description of the boiler

Boiler TKAN is developed as the Company RADIJATOR ENGINEERING might offer to the market the boiler, which by its mechanical and thermal properties is specially intended for biomass as fuel. Using the general term "**BIOMASS**", of course, it is primarily meant and considered - the pellet, but it should be noted and the possibility of firing the seeds of fruit (cherries, blackcherries...). **If the user wants to use some form of biomass that is not listed, be sure to call the service design and development RADIJATOR INŽENJERING or an authorized dealer, because very often some forms of biomass require a separate, specific combustion solutions.** When using these fuels means the automatic control of the main operating parameters. In all stipulated examples of using biomass it requires a certain degree of dryness of the fuels. On the other hand the requirements of the markets are always facing as bigger common universality of fuel as possible, so you can fire up the Boiler TKAN with solid fuels (wood) and then the firing is manual.

The combustion itself takes place in the condition of forced draft generated by fan, so the Boiler TKAN in these conditions is more efficient than its predecessors, which operate on the principle of free airflow.

Wood pellets are produced from 100 % cellulose. Wood residues under high pressure are compressed into pellets of 6 mm in diameter and in length of 2- 3cm. Pellets should be stored correctly in a dry place to ensure efficient combustion. Boilers TKAN1.1, TKAN1.2 and TKAN2 use pellet of 6mm diameter, of 5 -30mm length and humidity up to 10 % manufactured in accordance with **EN 14962-2**.

Series of boilers TKAN IS MANUFACTURED in three variants: TKAN1.1, TKAN1.2 and TKAN2. TKAN1.1 covers the power range of 8.1 – 27 kW, TKAN1.2 is in the power range of 8.1 – 34.9kW and TKAN2 is in the range of 14.5 – 49,5kW.

There are valid certificates which confirm emissions during operation of pellet boilers, at present there are no such certificates when the fuel used is wood, and in this case, we recommend installing the reservoir (accumulating hot water) for heating of the volume 55L/kW of nominal power (in some markets such as: .SLOVENIA markets, this is not a recommendation for the customer but the legal provision).

CONSTRUCTION

According to exterior design, the furnace dimensions, openings for firing and cleaning TKAN kept all good features of previous models by which **Company RADIJATOR INZENJERING** is very well known in the market.

The water portion of the boiler, its mode of heat exchange between the flue gas and water is adjusted to the application of biomass and coal. Due to the use of fans, ie. Due to forced draft the

path of flue gas is longer than with standard boilers. For the same reasons it is possible to use a router for flue gases, the so-called turbulators, which increase the degree of efficiency of the boiler.

Efficiency of pellet is over 90 %. In normal mode the flue gas temperature at the exit is about 120 ° C, and in maximum regimes it is below 150 ° C. These values may at any time to observed on the display. Each TKAN boiler has a copper heat exchanger for the connection of the fan for thermal safety as well as the flap for fire initiation. All parts of the water portion of boiler are made of seamless pipe ST 35.4 quality and boiler plate thickness of 5 mm or more, depending on the power of boiler. Sheets are of the quality of the Standard 1.0425 EU i.e. Standard P265GH EUII.

Combustion chamber, in its principle of work. The so-called „spring up", where the zone of transport of fuel is going vertically upwards i.e. it springs up to the combustion zone. It is made of solid insulating materials and cast iron. Fuel transport is provided by screw transporters. The fuel is coming from the silo of the capacity of 240 L. If necessary, it is easy to dismantle the whole assembly into three independent entities: silo, the mechanism for setting and boiler.

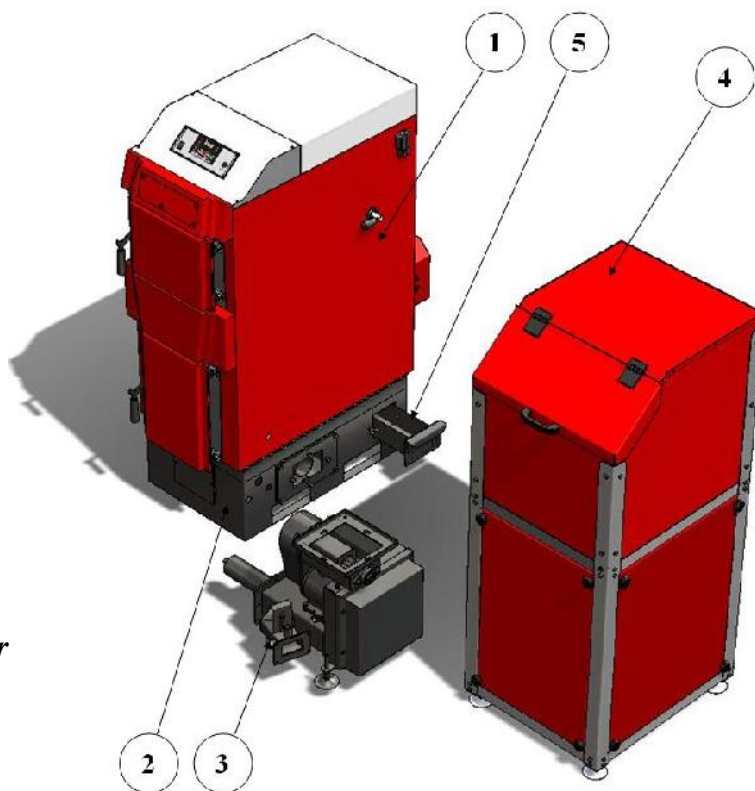

Figure 1. Parts of boiler

Discription:

1. Body of boiler;
2. Combustion chamber;
3. Feeder;
4. Silos;
5. Ashtray.

3. Assembly

3.1 General warnings

The boiler must be set correctly for proper operation!

The boiler is supplied with an external coating containing insulation, 30mm thick.

The position of the silo and the mechanism of transport of pellets is a standard factory right in relation to the boiler. It is possible to order the factory assembled and left variant. Also, if you need to easily make changes in the field because the silos and the whole mechanism disassemble dosing in relation to the boiler. Electrical connections easy switch ON easy OFF, and reassembly is not necessary personnel specialized electrical field.



Silos for TKAN 1.1, TKAN 1.2 and TKAN 2 have a flexible connection with the transport mechanism, in order to avoid vibration during operation.

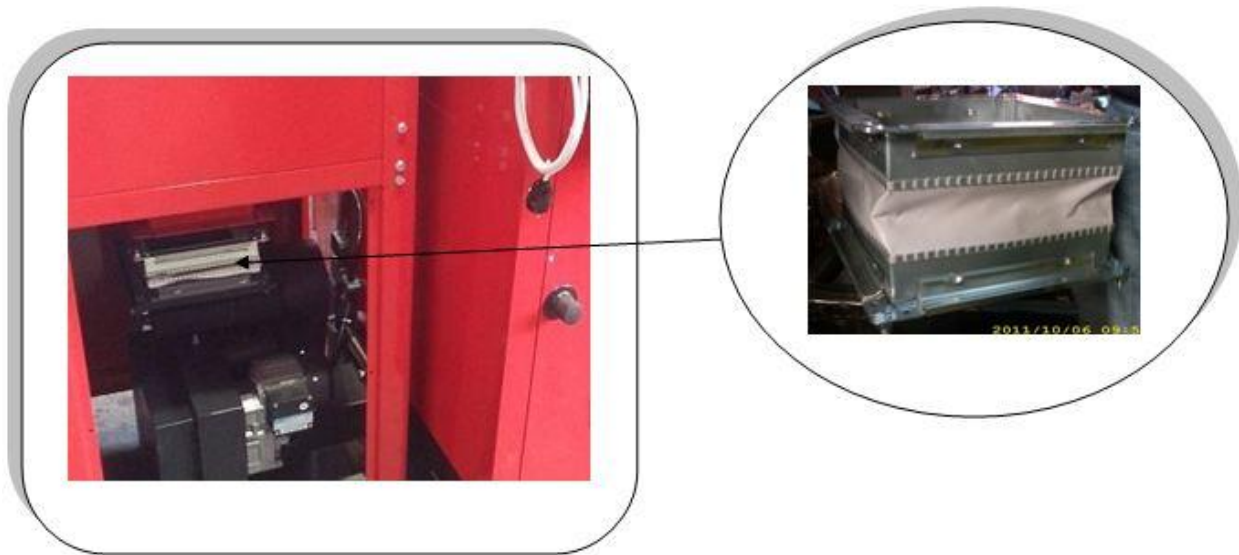

Figure2. Preview flexible connections



Maximum operating pressure of the boiler is 3 bar, 1 bar the minimum and maximum operating temperature of the boiler is 110 C.



Solid fuel boiler and forced draft should be installed according to valid standards and legal regulations. Any mechanical or electrical change in the design or installation shall be deemed a violation of guarantee conditions and will lead to its distortion.



The boiler together with a fan and automation system and both devices, use the power supply of 230V, so that improper installation and careless handling can endanger human lives by electric shock.



In an assembly the boiler should be properly protected against the excessive overpressure and overheating.



For the proper installation the plumber/installer is responsible.



The manufacturer (Radijator inzenjering) does not take any responsibility coming from the incorrect installation of the boiler.

The basic requirements to be complied with during the installation:

- The boiler can be connected to an open system of central heating, but also to a closed system of central heating. In case of connection to a closed system, it is recommended to install the valve for thermal insurance, which is determined by the respective laws of each state in which the boiler is connected.
- The boiler must be located at a safe distance from combustible materials.
- Electric power for the Boiler is 230V 50Hz and connection of all devices that the boiler has should be done according to valid regulations and connection is done by a person with proper authority.
- Connection to the chimney also done according to the binding regulations and manufacturer's recommendations as can be seen below.

3.2 Measures and safety devices for boilers TKAN;

For safe operation of boiler it is necessary to assemble and maintain the following elements in working condition:

- **Pressure Safety valve (figure 3)**



Figure 3.



Figure 4.



Figure 5.

- Pressure safety valve must be of nominal diameter of 1/2 inch calibrated to a maximum of 3 bars.
This security element which belongs to the group of pressure limiters must be of such construction to withstand short-term overdrafts and temperatures and pressure as well as the content in the liquid glycol for heating.
Usually in the same place the vent (**Figure 4**) and the pressure gauge (**Figure 5**) are connected so that these three elements together constitute a security group and can be mounted over T" connector.
This safety element must be subjected to periodic re-calibration , of which the investor, i.e. the user of the boiler must have valid documentation.
- Safety valve must be mounted on the highest point directly to the boiler and the boiler without any pipeline or any other elements in between. For this purpose there is a specially designed connector (see picture). Any reduction in diameter of the connector is prohibited.
- Ispusni tj. izduvni deo ventila sigurnosti mora da bude od cevi iji je pre nik najmanje jednak nazivnom pre niku ispusnog dela ventila.Tako e dozvoljeno je za njegovu izradu koristiti najviše jedan luk radijusa $r > 3d$.
- The safety valve must have a nameplate and the following information on it
 - Name of manufacture;
 - Designation of type of safety valve / year of testing;
 - Nominal flow rate;
 - Data for which thermal effect the safety valve is set;
 - The highest opening pressure 3 bars.
- It is obligatory to check the correct functioning at regular intervals as well as the re-calibration by certified companies. These responsibilities are carried out in accordance with the law of every country in which the boiler is assembled. Always keep the written documentation of the last calibration data for the safety valve.
- On the return line assemble at least another pressure safety valve.

- The valve of thermal safety by swelling (Figure 6)



Figure 6.

This safety element also has a role of a limiter of temperature. Below it will be marked with the abbreviation VTO.

- In some extremely dangerous situations in the transformation of water into vapor is such that the pressure safety valves are not sufficient to ensure the safety of the hydraulic system. For this reason, the installation of VTO is mandatory. Depending on the regulations of the countries in which the boiler is assembled, it is necessary to install the VTO only for the determined higher powers or for each power of a boiler it is the obligatory to instal the VTO.
- Place the installation is shown in the Assembly diagram of boiler onto the installation in **Figure 7**. The boiler is supplied with a copper coil so it is necessary to use the VTO with trhe exchanger, as shown in **Figure 7**. Cold sanitary water is brought to the VTO. When the VTO-probe has the information that the temperature is over 95 degrees the VTO is opened and water flows through copper coil. After some time the temperature of water in boiler returns to its normal state.
- One connection of coil is used for VTO and the other for draining of water that has passed through the coil. The choice of either connection; for VTO or for the discharge is irrelevant. It is necessary to follow the installation instructions provided by the manufacturer of the VTO.
- Be sure to check up, in certain periods of time, the functioning of the VTO.

As stated above one end of the VTO is for the mounting on the exchanger of the boiler, and the other is supplied with cold water under pressure. It is particularly important that the water flow is unobstructed even when the electricity is switched off.



If it is impossible to provide the inflow of cold sanitary water at the time of electricity switch off , the boiler must be connected onto the open system.

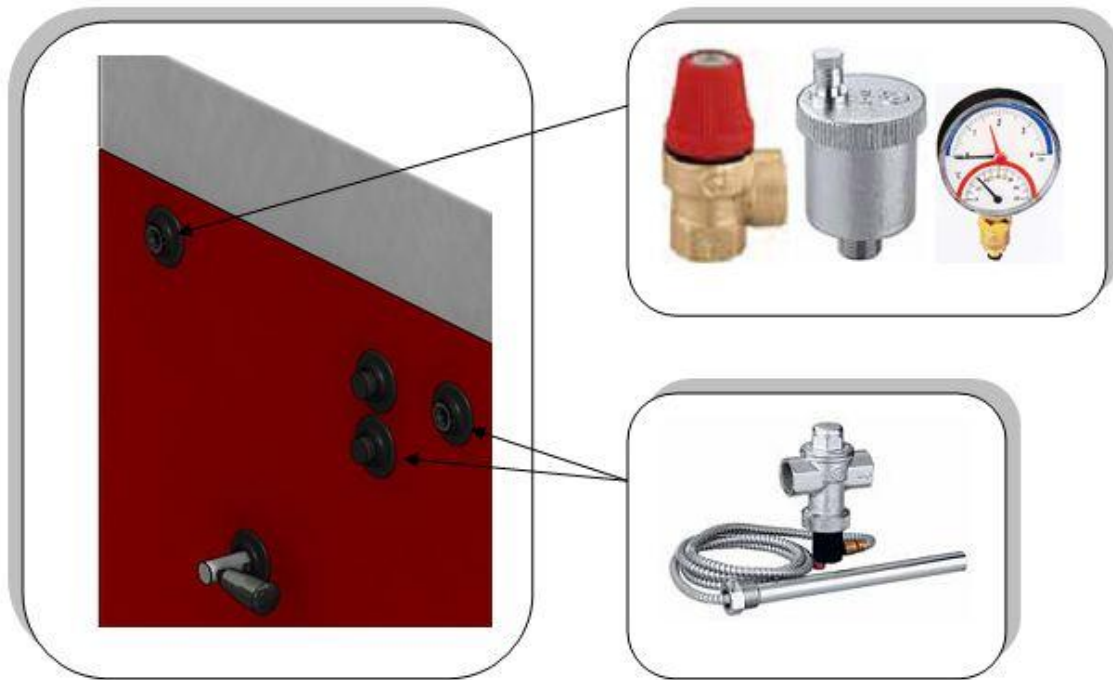

Figure 7. Installation of safety elements

- Thermostats in the automation of the boiler (Figure 8)

Within the automation itself that leads the combustion process and influences the work of two cycles of heating, there are two thermostats. Both are of similar construction as the thermostat shown in figure 8 and they have safety functions as limiters of the temperature of water in the boiler. Because of the safety role in the functioning of the boiler, both thermostats have the independent probes for measuring of water temperature. The first thermostat is the so-called „working thermostat” work and it serves to limit the temperature to a level the user wants. Another thermostat is the „safety thermostat” because it stops the operation of the fan which favors the flame, and adds a new energy. Safety temperature is limited to 95 degrees Celsius.

It is very important to connect the pump for heating through automation for safety reasons. When the temperature of water in the boiler reaches the critical value of 95 degrees the fan stops working, but the pump is necessarily switched on to exchange the heat of water through radiators.

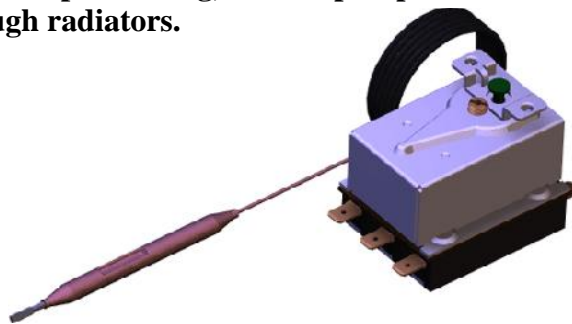

Figure 8

3.3 Boiler room

Boiler room must be secured against freezing.

The support surface of the boiler in the boiler room must be of non-combustible material.

Recommended distance of all four sides of the boiler in relation to the boiler walls or other solid body (water heater, etc.) are shown in **figure 9**. These values allow a safe distance access when firing, sufficient space for cleaning and easy access to fan and valve for filling and emptying.

Boiler at its left hand side should be away from the wall 200 mm i.e. as much as needed for the connection of valves for thermal safety by over flow. If the valve is not to be installed then the space can be smaller. The flap handle for firing is removable and can be placed either on the left or right side of the boiler. The space on the right side of the boiler, which is recommended to be at least 800mm from the silo is important because after cleaning the boiler the user then goes and pulls out the ashtray from the back of the firebox. **Boiler room must have sufficient ventilation holes for fresh air as well as for the outlet of the exhaust air.**

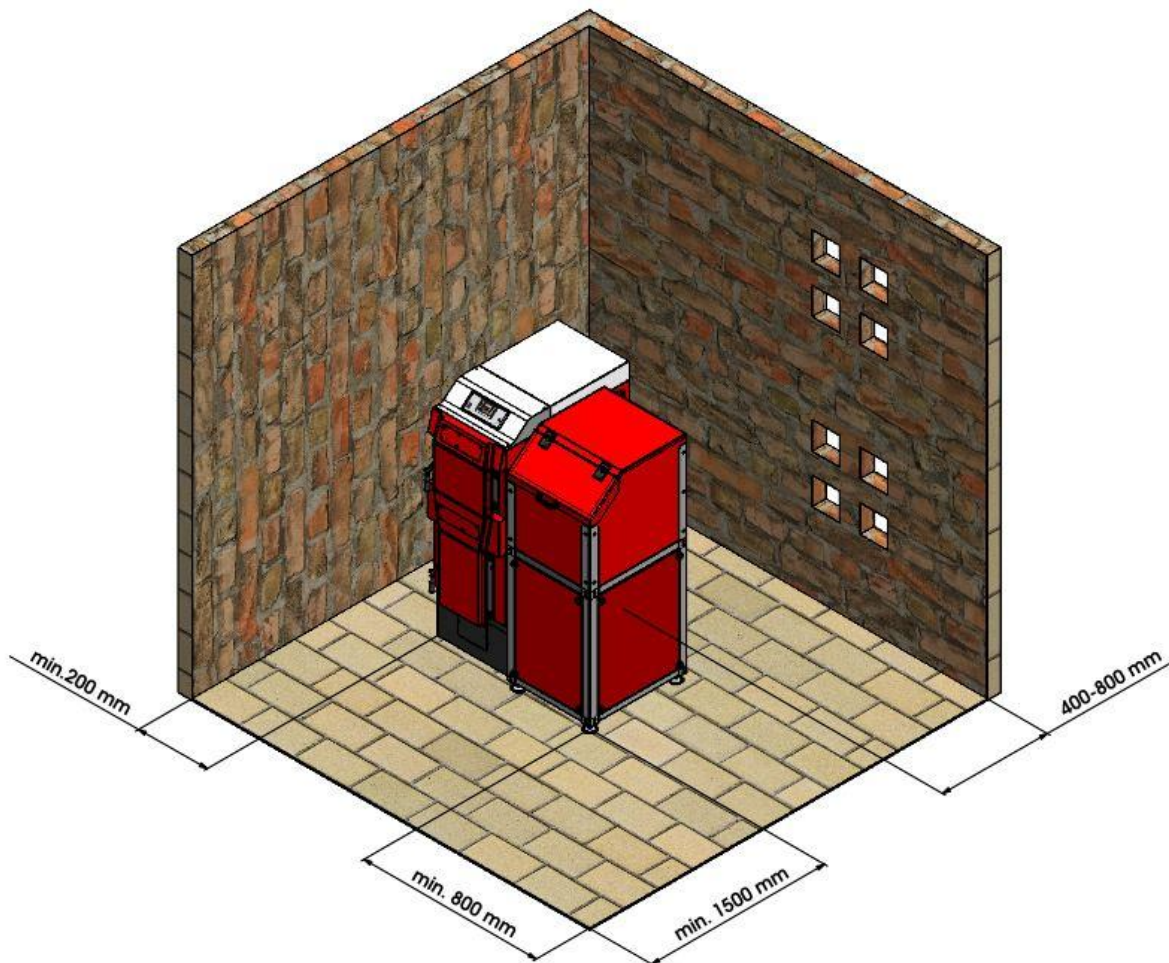

Figure 9. Positioning of boiler in the Boiler room

Total space of this openings is minimum 150cm² fro the boilers of the power of 50kW and for the power over 50kW the space must be larger for another 2cm² per 1kW.

$$A=150\text{cm}^2+\frac{2\text{cm}^2}{\text{kW}}\times(\sum Q_n - 50\text{kW}) \quad \sum Q_n = \text{possible power of over 50kW.}$$

The lack of sufficient ventilation in the boiler room can cause more problems in the work of boiler. Main problem is the inability to achieve high output water temperature i.e. the lack of maximum power which leads to condensation in the boiler.

- Take into account the required minimum space required for access and security elements to carry out cleaning operations.
- Determine whether the degree of electrical protection is in accordance with the characteristics of the room where the boiler will be located.
- No exposure to atmospheric influences. The boiler itself is not anticipated for outdoor use and contains no anti-freeze system.
- It is forbidden to close the vents in the boiler room in which the openings are necessary for proper combustion.

3.4 Connection to the chimney

The boiler TKAN works on forced draft, but the rules should be respected as if the selection of the chimney were for the boiler working on over-pressure in the combustion chamber some other fuel, like oil fuel, for example. Otherwise the problems may occur in the work, especially in the ignition phase and in the mode of solid fuel.

It is recommended that the diameter of the chimney is at least equal to the diameter of the flue has, and minimum height of 7 to 8 meters, depending on the coverage of the chimney by some other high buildings next to it.

The most optimal positioning of the boiler onto the flue outlet is such that connecting the center of the exit gases from the boiler flue and chimney connection to the center is slightly raised (up to 3 %) (see **Figure 10**).

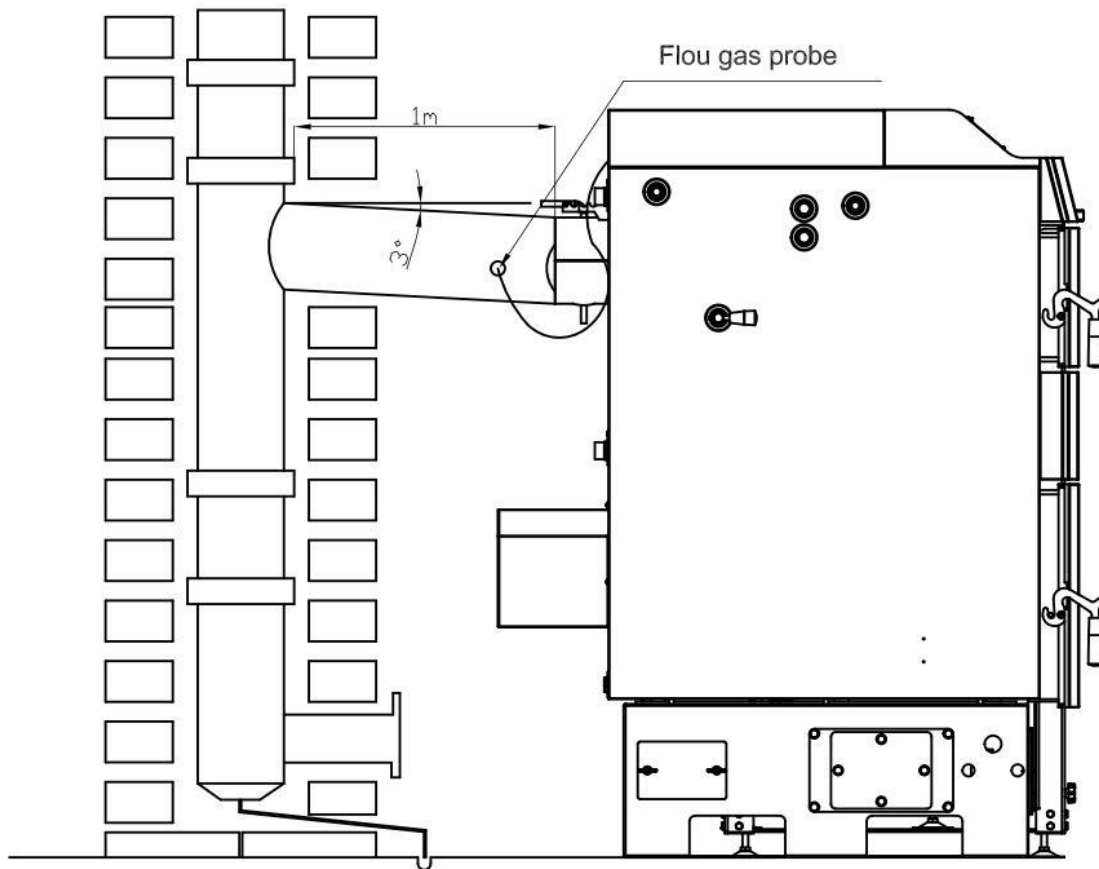

Figure 10. Connection to chimney

If possible, arcs should be avoided, but if not possible, then the maximum number of arcs is 2. The fume channel from the boiler to the chimney, should desirably be insulated, specially if it has arcs and longer sections.

On the smoke pipe, approximately 100mm from the flue outlet from boiler, a hole should be drilled and a temperature gauge should be mounted for flue gas temperature measurings. Without information about the temperature of flue gases there isn't the automatic mode of the boiler.

The chimney itself should be made of ceramic pipes, and around them there should be the insulation of 3- 5cm thickness and the outer layer is of the bricks or special elements. If the chimney is not from ceramic pipes but of bricks, the light opening area of such chimney shall be 30 % higher than the surface of this ceramic pipes chimney. Minimal sectional dimensions of both chimneys and the minimum heights are given in table 1.

The chimney must have a door for cleaning and it must be well sealed. Chimney outlet on the roof must be according to certain regulations. There are two cases: if the angle of the roof is less than 12° and if the roof angle is bigger than 12° . For angle less than 12° the height of the chimney above the roof is 1 m and for the larger than 12° , then look at the sketch.

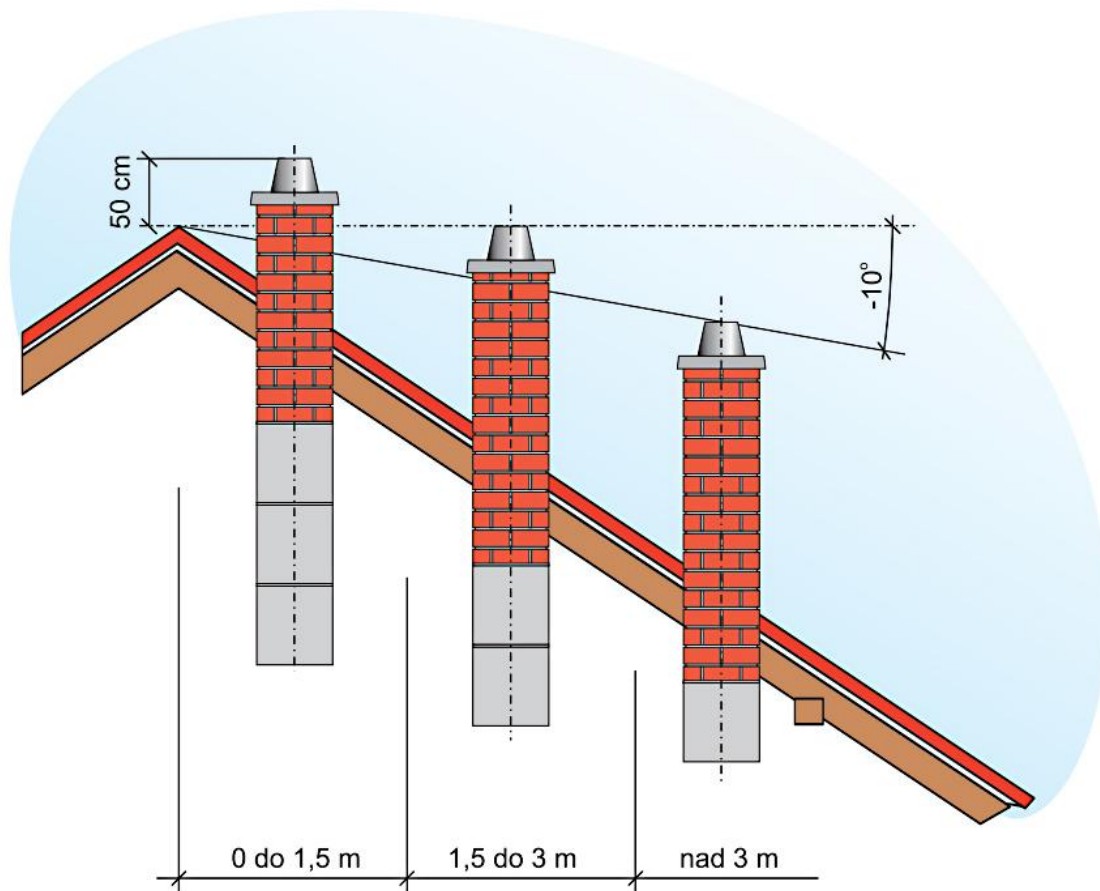

If you think that the chimney is too strong and too much cold air passes through the boiler, at the exit of the boiler there is a valve which can reduce the flow of exhaust gases. The chimney should be cleaned regularly or at least once a year.



If the chimney is not of proper height, cross section, or if it is not enough clean as possible, then the complications in the work of boiler are possible. First, of all it is not possible to achieve the high temperature regime of work, i.e. there is not the maximum operation power, and the consequence of that is the occurrence of condensation which affects the life of the boiler.



Weak/poor chimney is the main reason when during the ignition of the boiler or during the operation there is the appearance of smoke on the upper or lower door, especially at higher fan speeds.

4. Cross-section of TKAN Boiler with a description of the boiler elements

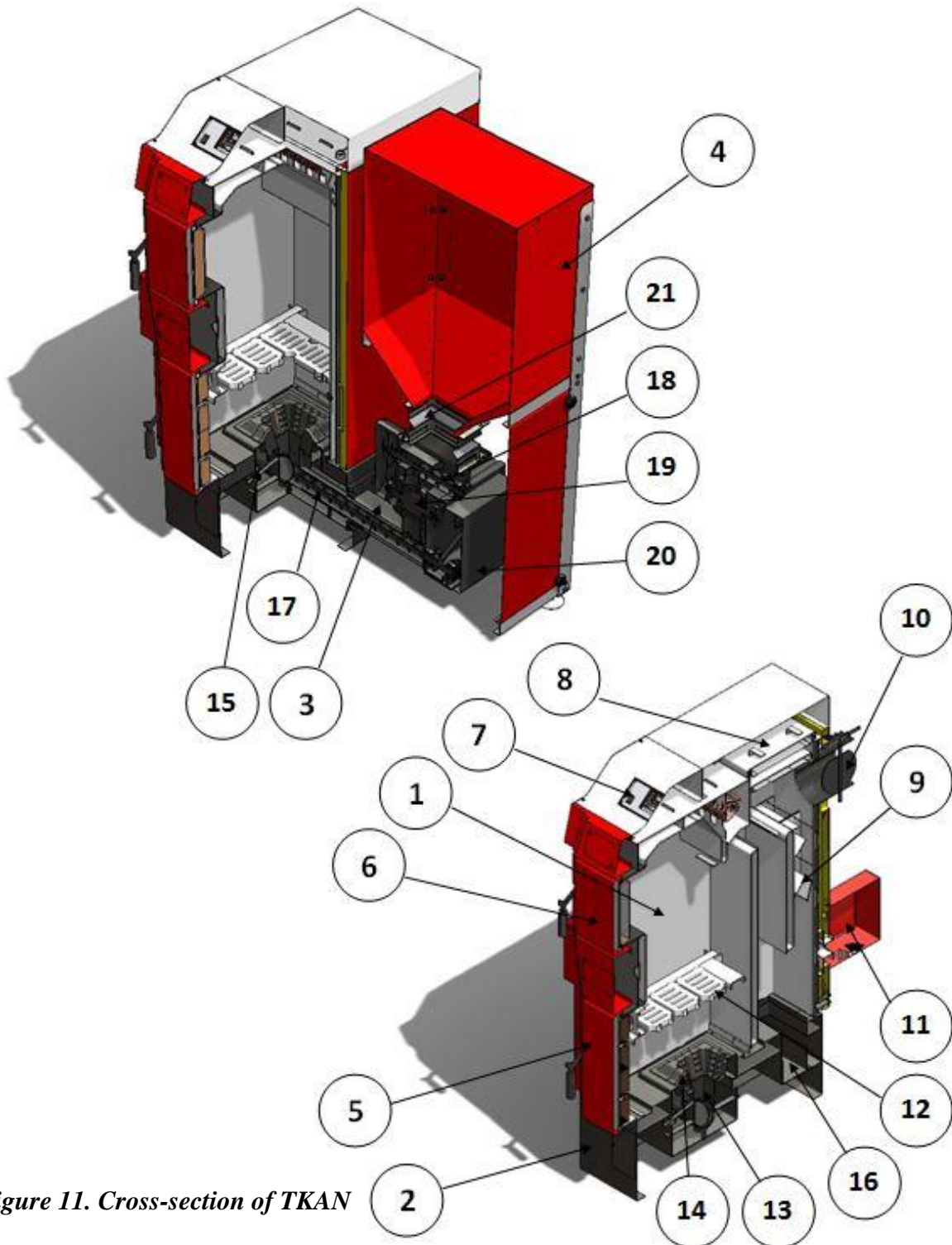
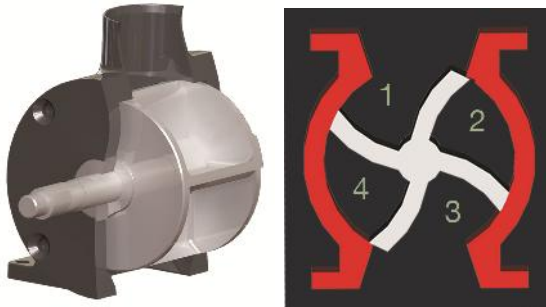

Figure 11. Cross-section of TKAN

Description:

1. Body of boiler;
2. Combustion chamber;
3. Feeder;
4. Silos;
5. Lower door for firewood and cleaning;
6. Upper door for wood loading;
7. Automatic
8. Cover for cleaning;
9. Turbulators;
10. Chimneys;
11. Secondary fan;
12. Gratings (cast iron gratings)
13. Combustion pellets;
14. Cast iron elements;
15. Ignitioner;
16. Ashtray;
17. Lower screw conveyor;
18. Upper screw conveyor;
19. Rotation safety element;



20. Box for chainwheel and bearings;
21. Flexible connection.

5. Schematic connection of automation

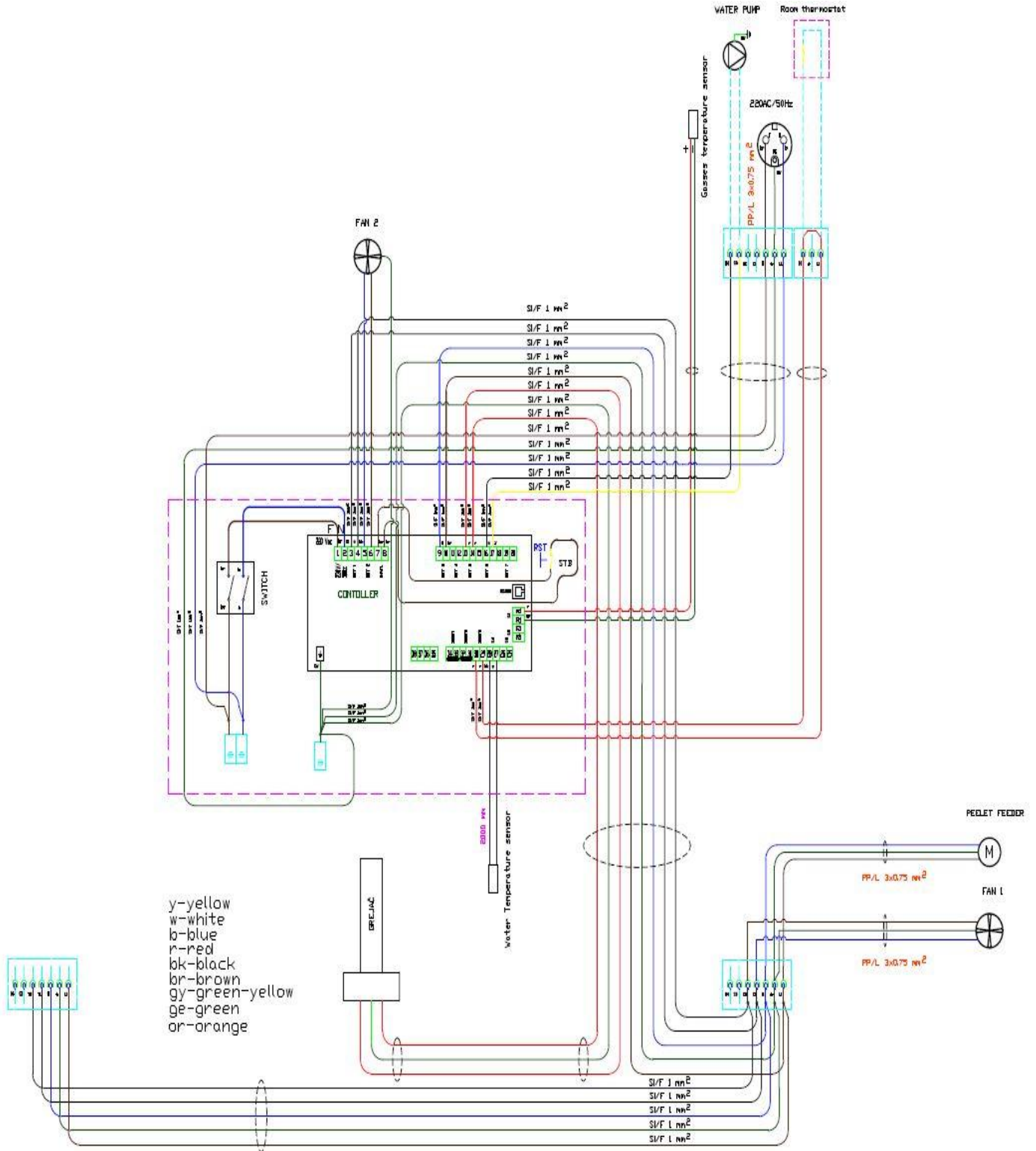

All lines that are displayed in the intermittent form in the diagram of external connections are the conductors which should be installed by the technician when connecting the external devices onto the automation system of the boiler. All the connections of the additional devices are performed by the technician through three connectors located at the rear of the boiler. Two connectors are three-pole connectors while one is seven-pole connector. One three-pole connector serves for the connection of the room thermostat as shown on the label the connector itself.



For the room thermostats it is important to be battery-powered on, i.e. they should not have any supply of the voltage of 220 V. On the thermostat for the connection NC is used (normally closed contact).

Seven-pole connector is for connecting network cable and for the connection of the circulation pump and the battery pump i.e. of the heater for sanitary water.



The boiler can operate even if none of the pumps is connected, but manufacturer's recommendation is that, at least, the pumpa1 (central heating pump) because it has the function of a security element. It is switched on when the boiler water temperature exceeds 90°C.

6. Table of technical data

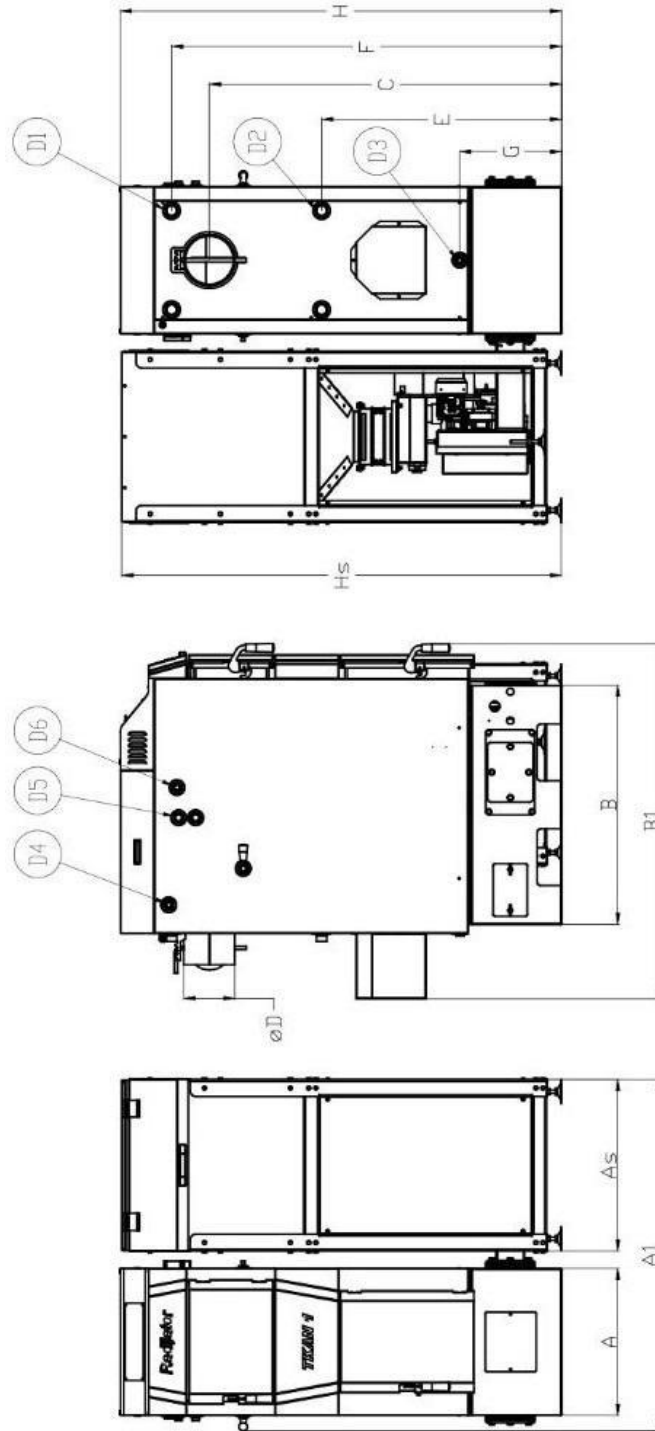

Type of boiler		TKAN 1.1	TKAN 1.2	TKAN 2
CE designation		CE	CE	CE
Class of Boiler according to EN 303-5:2012		5	5	5
Working Pressure	bar	3	3	3
Test Pressure	bar	4,5	4.5	4,5
Volume of combustion chamber	L	50	50	80
Volume of water in the boiler	L	97	97	125
Weight	kg	635	635	787
Cross section of chimney	mm	180	180	200
Necessary chimney draft	mbar/Pa	0,18/18	0.18/18	0,18/18
Boiler temperature (min / max)	°C	60-90	60-90	60-90
Minimum return temperature	°C	60	60	60
Efficiency degree at nominal/minimal thermal power	%	92,45/92	91.78/92.56	90,05/90,01
Nominal Power	kW	27	34.9	49,5
Minimum / Maximum Power of Boiler	kW	8,1-27	8.1-34.9	14,5-49,5
Carbon monoxide (CO) with a minimum thermal input (10%O2)	mg/m3	131	114.38	122
Carbon monoxide (CO) at a nominal heat power (10%O2)	mg/m3	300	100.69	101
Dust at nominal/minimal heat power (10%O2)	mg/Nm3	22,2/ 28,29	16.96/ 17,42	16,25/ 18,01
Dimensions				
	A	520	520	670
	A1	1210	1210	1340
	As	610	610	610
	B	845	845	960
	B1	1270	1270	1325
	C	1245	1245	1350
	ØD	180	180	200
	E	850	850	470
	F	1380	1380	1465
	G	360	360	360
	H	1560	1560	1670
	Hs	1560	1560	1560
Connections for hot water boiler from boiler	D1	1"	1"	5/4"
Connections for cold water boiler	D2	1"	1"	5/4"
Connections for filling and emptying boiler	D3	1/2"	1/2"	1/2"
Connections for the safety valve and vent pressure	D4	1/2"	1/2"	1/2"
Connector for thermal valve insurance swelling VTO	D5	1/2"	1/2"	1/2"
Connections for probe VTO	D6	1/2"	1/2"	1/2"

7. Hydraulic scheme

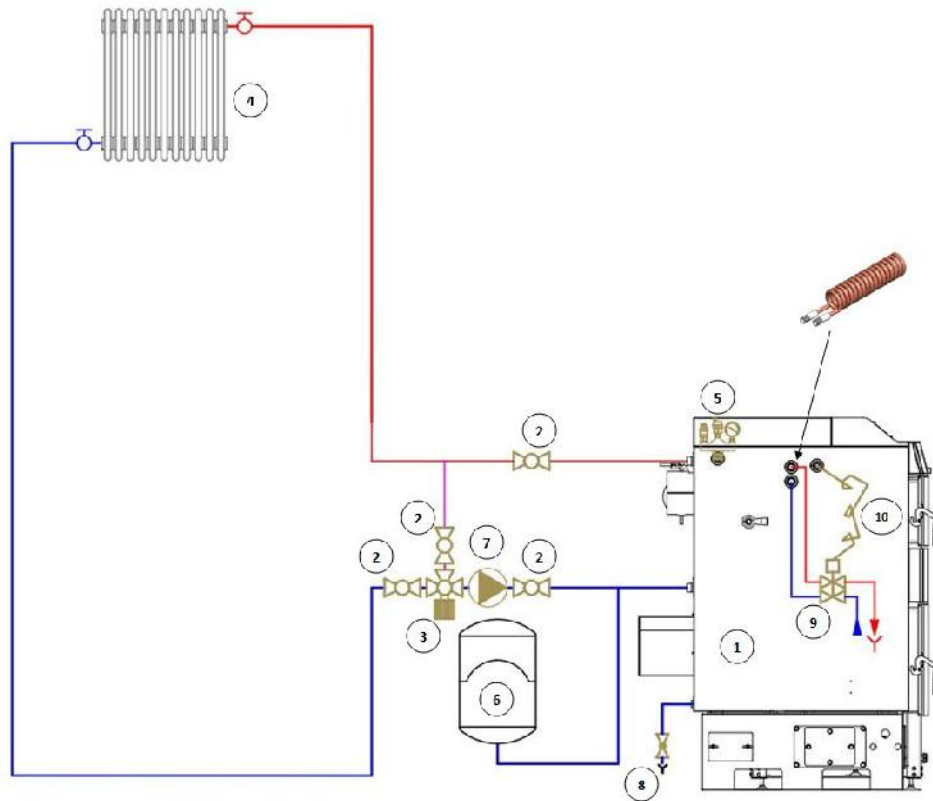

Hydraulic scheme

Description:

1. TKAN Boiler;
2. Valve;
3. Mixing valve;
4. Heat exchanger;
5. Safety group;
6. Expansive vessel;
7. Pump;
8. Valve for filling/emptying;
9. Over heating temperature safety valve;
10. Probe for hot safety valve.

! *In an assembly the boiler should be properly protected against the excessive overpressure and overheating.*

! *For the proper installation the plumber/installer is responsible.*

! *The manufacturer (Radijator inzenjering) does not take any responsibility coming from the incorrect installation of the boiler.*

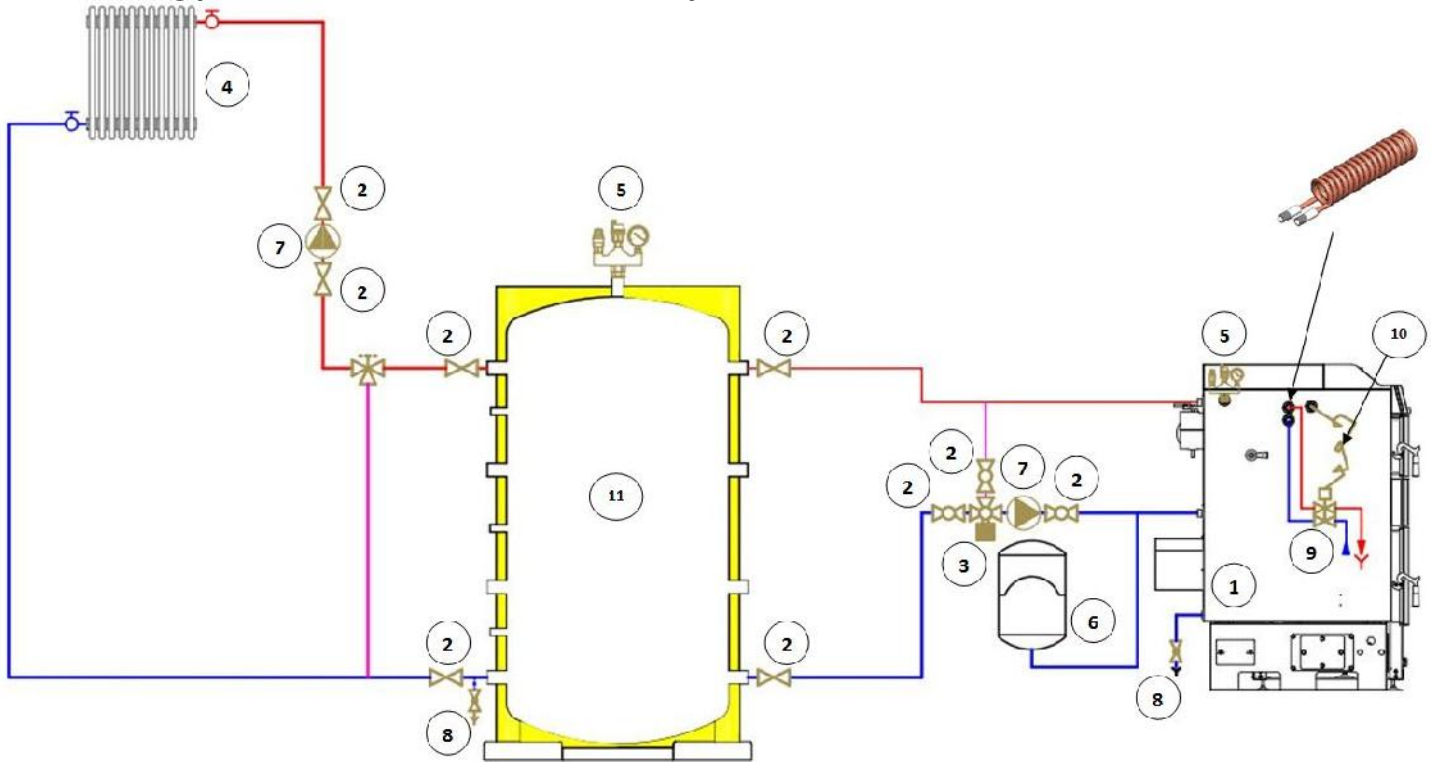

Hydraulic schema with puffer

Discription:

1. TKAN Boiler;
2. Valves;
3. Mixing valve;
4. Heat exchanger;
5. Safety group;
6. Expansive vessel;
7. Pump;
8. Valve for filling/emptying;
9. Over heating temperature safety valve;
10. Probe fot safety valve;

8. Start of boiler operation and cleaning



First Commissioning of the boiler is performed by a Technician who has a Certificate issued by the “Radiator engineering” Co. Training of boiler users is mandatory.

In this way, the person is authorized to notify the customer service in the factory, time when the boiler started its operation in the condition of the boiler at its first firing, while a copy of the commissioning of the boiler in operation is retained. Guarantee and instruction manual are given to the customer. One copy of Guarantee is sent to the manufacturer.

If the guarantee is not filled in, it is not valid.

Only boilers that are operated only by authorized persons subject to technical conditions of complete guarantee of two years.

The following text is intended for the user of the boiler, as a kind of reminder, that if you turn off the boiler (eg for cleaning) will be able to independently run the boiler.



The parameters related to the operation of the boiler and which are available to the user on the display. Other parameters that are called hidden menu should not be changed without the approval of the technical person who has put the boiler into operation or the factory.

8.1 Control panel

Control panel consisting of:

The main switch, safety thermostat button, the display, the group command buttons (buttons), a group of light-emitting diode pointer

The picture below is the image of the Control Panel.

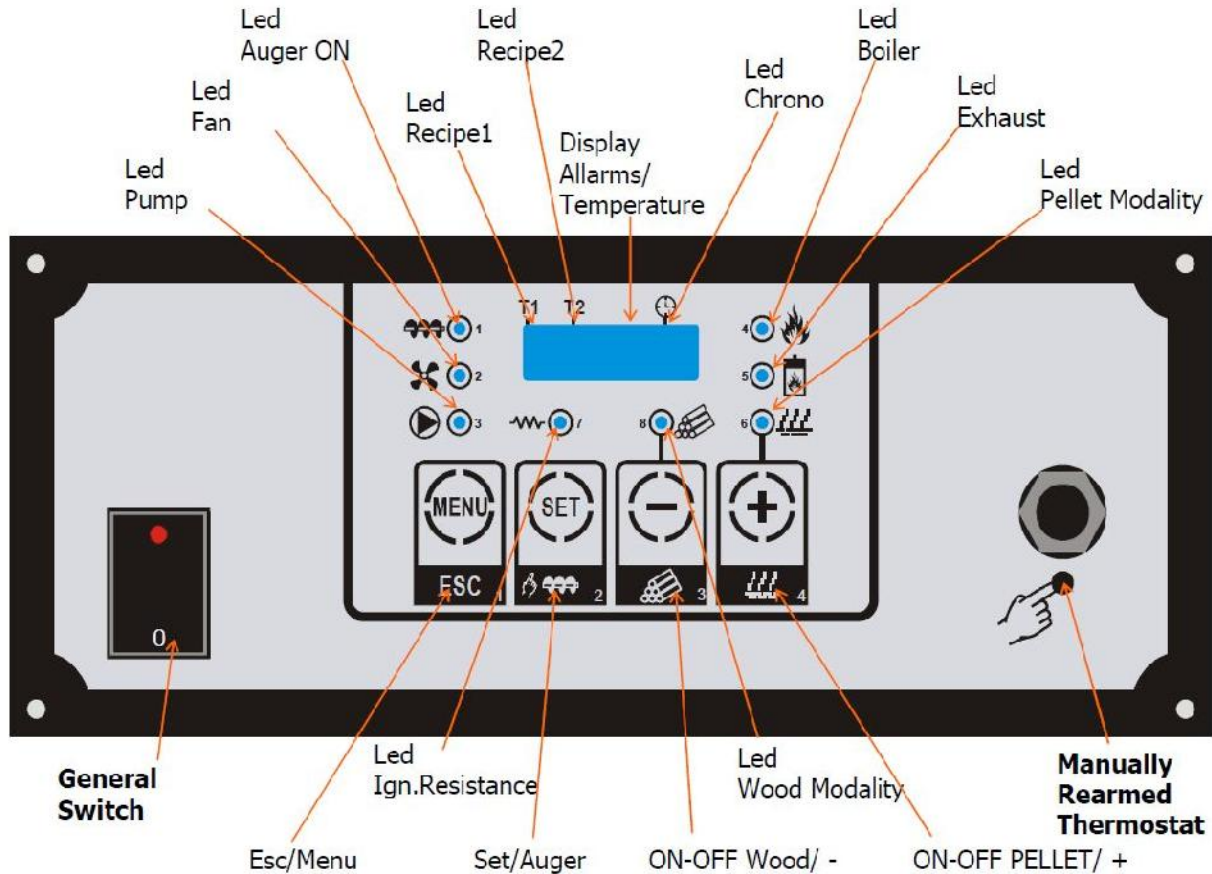

8.1.1 Buttons

- **ON-OFF Pellet/ +:** If pushed for five seconds it switches on the system goes in ON/OFF Pellet
If pushed in **Menu** it increments a parameter's value.

- **ON-OFF Wood/ -:** If pushed for five seconds it switches on the system goes in ON/OFF Wood
If pushed in **Menu** it decrements a parameter's value.

- **SET/Auger:** If you keep this button pushed when the system is **Off** it activates a manual load of the auger. During this procedure you will see "**LoAd**" on the Display.
The manual load procedure ends when you release the button.

If pushed in **Menu** it changes the visualization from parameter's code to

parameter's value and it permits to save a new setting.

-ESC/Menu: This button allows to enter/exit the Menu. If you are changing a setting and you push this button you will exit without saving the new value.

NOTE:

In **OFF** or **Extinguishing** state you can reset an Alarm visualization by pushing (+) or (-) button, but if the alarm were still there you would visualize it again.

8.1.2 Led

1. **Led Auger :** It is ON when the Auger Output is ON.
2. **Led Fan :** It is ON when the Fan1 Output is ON.
3. **Led Pump :** It is ON when the Pump Output is ON, it blinks when the Pump is switched OFF by the Room Thermostat input.
4. **Led Boiler:** It is ON when the Water Temperature is under the value **BOILER-TH[A03] – ModulationDelta[A05]**.It blinks when the water temperature is over that value.It is OFF when the temperature is over the **BOILER-TH[A03]**.
5. **Led Exhaust :** This Led is ON when exhaust temperature is over the **TH-ON [F18]**,It blinks during the pre-extinguishing phase.
6. **Led Pellet :** The Led is ON in Pellet Modality Blinking during **Pre-Extinguishing-TIME t06**
7. **Led Ign.Resistance :** This Led is ON when the Ignition Resistance Output is ON
8. **Led Wood:** The Led is ON in Wood Modality
9. **Led Recipe T1 :** This Led is ON if Recipe1 is selected.
10. **Led Recipe T2 :** This Led is ON if Recipe2 is selected.
11. **Led Chrono :** This Led is ON when the Chrono input contact is closed.

8.1.3 Display

Display\Temperature\State\Alarms:

The 4 digit Display visualizes water temperature, the functioning State of the system and eventual alarms:

Display	Discription	Display	Discription
OFF	OFF state	Mod	Modulation
Chc	Check up	RRn	Stand by
Acc	Ignition	S,c	Safety
Stb	Stabilization	SPE	Extinguishing
rEc	Recover ignition	ALt	System off with alarms

If there are alarms the Display will show alternatively ALt / ErrorCode:

Display	Discription	Display	Discription
tS,c	Manually rearmed Safety Thermostat	SPAc	Accidental Extinguishing

	contact is open		
Si c	Over Boiler Temperature	Sond	Probe reading out of range
Acc	Failed Ignition		

NOTE:

- Switching on the control board by the General Switch, Product Code and Firmware Version are displayed for 2 seconds.

Display	Discription	Display	Discription
St08	Product Code	Ur 10	Program Version

8.2 Operation start of boiler on biomass

- Boiler connected to Hydraulic system.
- Drill a hole of 4 mm diameter on the upper side of fume pipe in the zone that is very close to wall outlet of the boiler. **(Figure.10)**

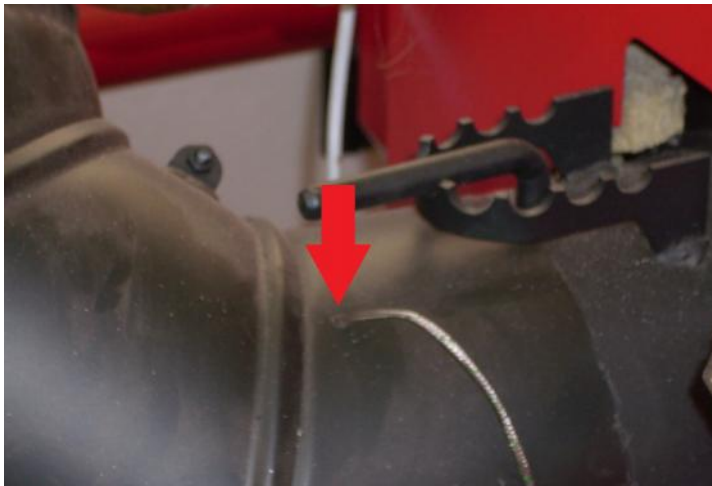

Figure 12. Placing the probe

- Check whether the mechanism for transport of pellet is firmly supported onto the floor, that the flap of the fan is maximum opened and the flap guide for safety air is from 15 to 20 mm. **(Figure.13 and 14)**



Figure 13. Position max. open of the fan flap



Figure 14. Position of fan flap.

- Flap of initiation of fire to be opened, i.e. the handle of this flap which is located laterally on the boiler should be pushed towards the fume outlet. (**Figure.15**)



Figure 15. Position of flap handle for- INITIATING FIRE

- Power outlet on the back boiler connected to the main power network.
- Infuse a small amount of pellets in the silos and close it.

- Prior to the ignition phase, grids are to be removed from the support. Grids are to be placed only when the boilers use wood as fuel.
- At this stage it is necessary to insert the pellets into the combustion chamber by means of the work of the transport mechanism for the pellet (pellet feeding system). In this way we achieve a continuously distributed pellet from the combustion chamber to the silo. The initiation of mechanism for pellet can be achieved only at the stage when on the display it says 'OFF'. Then press the command button 2, which in its lower part has a symbol of the screw conveyor, and the mechanism starts up. As long as we are holding the button pressed the mechanism is in operation. When we release the button the mechanism stops. Loading the pellet into the chamber, by the-so-called manual command is to be performed a little lower, up to the starting position of the parts of grey cast iron, as shown in **Figure 16**.



Figure 16. Level display pellets

- Now that we have the pellets in the combustion chamber and when they are in the zone of the heater for initiation of fire, we can start the operation of the boiler. Start is performed by pressing and holding the command button 4 for more than 3 seconds. On the lower part of this button there is the displayed symbol for the loose material or pellets.

At a time when the boiler goes on with the start of ignition, on the display there is the mark –written as Chc, for the few seconds only the fan is working. During this phase of the automatic system checks whether all devices necessary for the operation are actually connected.

The next step is when the display says Acc. This is the mark for the phase Ignition. Then, beside the fan, the heater for start of firing is switched, which can be seen on the automation display because the signal lights that are glowing are those with the numbers 2 and 7. In the stage ignition, at one time, it should be expected that the system for transportation should be switched and the level of pellets in the chamber should be re-filled. It is ideal, after this re-filling, the pellet should be located up to the beginning of grey cast iron parts.

The boiler is in the ignition phase until the flue gases exceed the temperature that is pre-determined by parameter. According to the factory settings, the temperature is 50. First the smoke appears and during the period from 7 to 10 minutes the flame is starting.

- When the flue gases exceed the limit temperature of the ignition on the display there appears the mark Stb. This means that the boiler flame is in the phase of stabilization, i.e. now the automatic system is measuring whether the flue gases have enough increase for certain time. The fan is working according to the parameter for the stabilization phase, and there is a supplement feed of the pellet in the firing chamber, also in accordance with the parameters of the screw conveyor in the stage stabilization. When this factor is satisfied the boiler goes into operating mode.
- The boiler is in operating mode when the display does not say anything except the current water temperature in the boiler. We should wait 20 to 30 minutes and see if the pellet is burning on the top of the firing chamber. Also, in this period we should monitor what the temperature of flue gases is. It is done by briefly pressing the command button 1 and then button 3, and at the end the button 2. Then on the display appears the number that indicates the temperature of flue gases. When this value is close to 200 degrees or slightly above, then the at the side of the boiler should be closed, **Figure 17**.



Figure 17. Position of flap handle (working position)



NOTE: These are the values measured during certification.

- The room thermocouple (thermostat) can be connected to automation system. In this case, it is important to adjust the room temperature, which is the main parameter for the operation of the boiler and water temperature in boiler (70 °C). When the room thermostat is activated, the boiler has the first need to reach the room temperature, under the condition that it is limited by adjusted degree of water temperature in it. There is a possibility that the boiler stops working before the adjusted temperature of the room thermostat, in this case the set temperature of the water in the boiler should be raised, Example to: 70 °C.
- The combustion of the pellets, regardless of the power at which the boiler is operating, it is necessary to adjust so that in the space at the top of the combustion chamber (**shown in the figure**). This is achieved by adjusting the dosage of pellets and by the amount of air. In the case the level of the flame begins to be lowered, it is necessary to extend the time of dosing or the reduction of the amount of air. If we want to reduce thermal power, it is necessary to reduce the amount of air. If it happens that the level of flame rises, we can reduce the time of loading or increase the amount of air. To accurately determine the parameters it is necessary to monitor the process of operation for at least an hour.

NOTE : Always, nominal or maximum power of burning wood pellets should be observed, i.e. when pellet is burned on top of the burner. In this case, the decrease of the heat power is performed by reducing the set boiler water temperature or set the temperature of the room thermostat.

Place where pellets „dancing“ during combustion



Warning: Be sure to make the analysis of the flue gases after the finish of installation of the boiler. Measure the percentage of oxygen (O₂).

8.3 Start of work of boiler by solid fuel

If the user wants the operation of the Solid fuel boiler the following steps should be taken:

- Before the use of the boiler on the wood set cast iron gratings.
- If the boiler had never been used on the pellets, but it is used for the first time using solid fuel, then it is necessary to pull in a small amount of pellets into the chamber. In this way the so-called false air through the feeding channels is prevented.
- Through the lower door, prepare a small amount of wood and start the flame. After the flame becomes more intensive add fuel. For the purpose of having less smoke the flap inside the boiler should be opened so that the handle, which is at the side of the boiler, should be pulled towards the chimney i.e. into the position "OPEN".
- Pay attention to the signal lamps No.6 and No.7. If the lamp No. 6 is on it means that the boiler is in working mode Pellet. Then command button No. 4 should be pressed for more than 3 seconds. In that way we are switching off the regime Pellet. Immediately after that press the command button 3 and hold for more than 3 seconds. In that way we are starting the operation regime Wood.
- After 20 to 30 minutes, when the boiler has been started to operate in normal operating mode, the flap inside the boiler should be brought back into work mode, then we pull the handle at the side of the boiler, towards the front door of the boiler.

The space for combustion of pellets should not be covered, at any account, with the ash boxes etc., because through this space the required air is provided for burning wood or coal.

8.4 Short manual for automatic control

8.4.1 Re-LOADING FIREBOX WITH PELLETS, PREPARATION OF STARTING

- Infuse pellets in a silos.
- The main display must write **OFF**



- Push the button and keep . As long as we keep working conveyor button and the display says **LOAD PELET**.

8.4.2 START IGNITION PELLETS, STOP WORKING ON PELET.

- Turn the main switch



- Push the button  and keep it in that position for 4-5 seconds.



- Break of operation of pellet boiler is done by pressing the button  and keeping for 5 seconds.

8.4.3 CHANGING FEEDING SYSTEM TIME ON OPERATING MODE.





- Push one short .



If the led next to simbol for auger blinked, then push button ,



with  and  change value of feeding system and again push the button



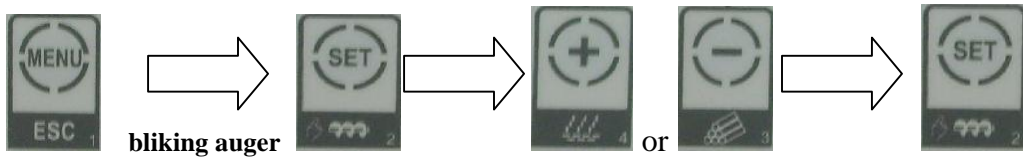

8.4.4 Change in volume fan operating mode.

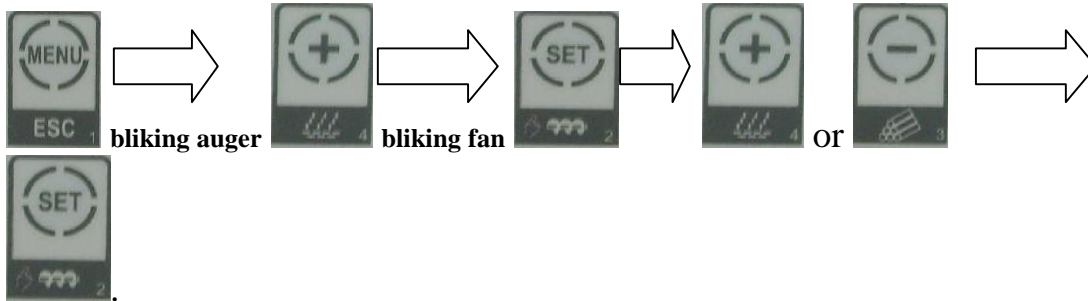

8.4.5 Change the set temperature in the boiler.

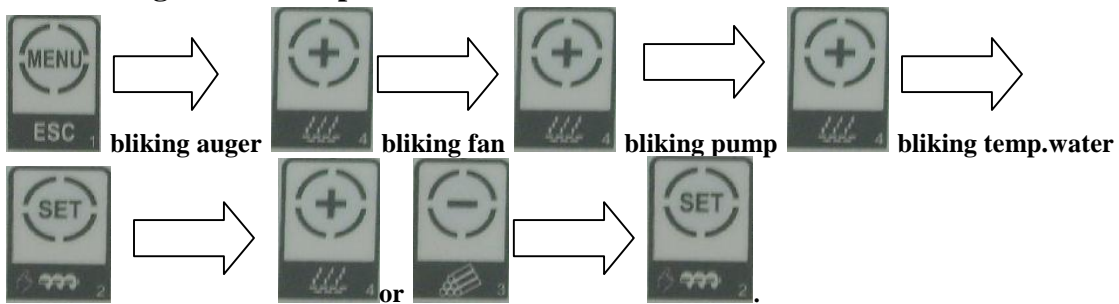

8.4.6 CHANGING THE WAY MANUEL OR AUTOMATIC IGNITION.

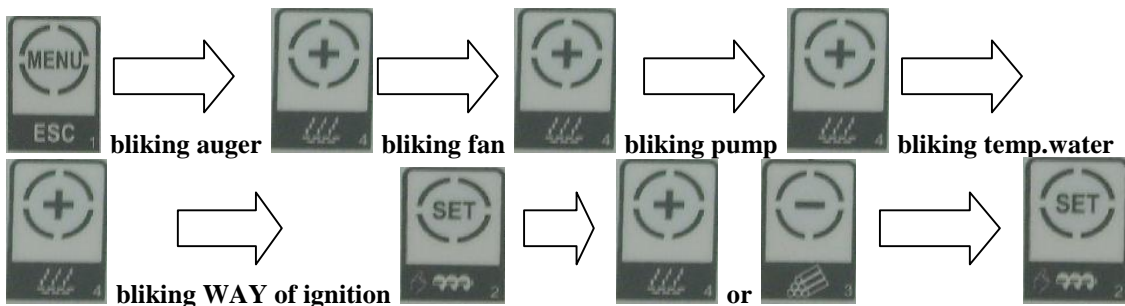

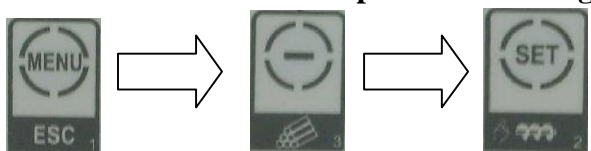

8.4.7 How to read the temperature of flue gases.



8.4.8 Entry into the hidden menu.



Push  and keep, immediately after push  and keep both buttons 5 sec. Immediately after entering in „hide“ MENI on display write **CL 00**. That is first parameter.

8.5 Mistakes during ignition and start of the boiler

All possible mistakes in the initial phase of operation, i.e. during the ignition, can be divided into three major groups:

- **Group I** . Mistakes in the ignition relating to the situation when there is not an occurrence of sparks, smoke or any flames for longer than 20 minutes from the moment you turned on the heater for ignition.
- **Group II** . Mistakes in the ignition related to the situation in the event the flame occurred, but the boiler after some time (a few minutes later) was extinguished.
- **Group III** . Boiler was successfully ignited and worked for several hours. It reached the set temperature, and for a long time there is no need to switch on either the fan or dosing system (usually this situation is during the night). Then the temperature drops or the user wants a higher temperature. (usually in the morning) and the boiler receives a signal to start the ignition phase, but the flame is out.

Group I

Possible **cause 1**.

- **CAUSE 1** – Closed fan flap for primary air. The fan is positioned on the dispenser.
- The procedure for **troubleshooting 1** – Open the fan flap at maximum.

Possible **cause 2**.

- **CAUSE 2** – The hose that connects the channel of the air from the fan to the heater is not properly set.
- The procedure for **troubleshooting 2** – Attach the air hose both onto the heater casing and the air duct

Possible **cause 3**

- **CAUSE 3** – The space between the heater and the pipe casing in which the screwed heater is clogged with tar and ashes so there is no air infiltration.

- The procedure for **troubleshooting 3** – Clean this area, first only try from the side inside the combustion chamber with the wire of the thickness 1-2 mm. If this fails switch off the boiler from the mains, now unscrew the heater and clean up the area in which it is located.

Possible **cause 4**

- **CAUSE 4** – Deep area of the combustion space where the pellets are burning is full of unburnt residues, i.e. of the slag so that there is no contact of pellets and hot air.
- The procedure for **troubleshooting 4** – Clean the deep area of the combustion chamber, first clean the rough particles of slag mechanically and the fine slag can be removed by means of vacuum cleaner.

Possible **cause 5**

- **CAUSE 5** – Pellets used are of high humidity.
- The procedure for **troubleshooting 5** – Try to use pellet that has a higher level of dryness.

Possible **cause 6**

- **CAUSE 6** – Electric supply voltage onto which the boiler is connected is much lower than 220-230V so the capacity of the heater is lower.
- The procedure for **troubleshooting 6** – Connect the AC Voltage adapter or ignite manually.

Possible **cause 7**

- **CAUSE 7** – After the manual setting and automatic addition in the ignition area the pellet level is such that the pellet is not in contact with the heater.
- The procedure for **troubleshooting 7** – Re-charge the level of pellets.

Possible **cause 8**

- **CAUSE 8** – The boiler is set from automatic to manual mode of operation. If, along the whole phase of ignition, the heater lamp is not lighted, then we are sure that the boiler is in manual mode.
- The procedure for **troubleshooting 8** – Switch the boiler into automatic ignition.

Possible **cause 9**

- **CAUSE 9** – Faulty electric heater for ignition. Switch off the boiler from the mains supply and on the the electrical heater cords measure the resistance.
- The procedure for **troubleshooting 9** – Change electric heater.

Group II

Possible **cause 1.**

- **CAUSE 1** – The flap in the boiler is closed which is operated with a handle positioned on the side. A lot of smoke appears and flue gases do not rise fast enough so the boiler is fading out.
- The procedure for **troubleshooting 1** – Open the flap, i.e. push the lever towards the chimney.

Possible **cause 2.**

- **CAUSE 2** – Fan speed in the phase of ignition. The speed of fan for primary air at this stage is determined by the parameters and Uc00 and Uc01. If the speed is drastically changed compared to the factory default adjustment it is not good nor is it significant to reduce or or to increase it. In case when the fan, in the phase of ignition, is weak, then there is no increase in temperature of flue gases, but if it is too strong it can cause the rapid consumption of pellets in the chamber, which in turn leads to a reduction in temperature of flue gases in the ignition.
- The procedure for **troubleshooting 2** – Adjust values of parameters UC00 and Uc01 the factory default or close to the factory default values.

Possible **cause 3**

- **CAUSE 3** – Fan speed in the flame stabilization phase. The boiler enters the ignition and the smoke appears, on the display it says Stb, which means that it is in the flame stabilization phase, but after that the boiler goes out. The most frequent cause for this is too weak fan in the stabilization phase which is adjusted by means of parameter UC04.
- The procedure for **troubleshooting 3** – Increase the fan speed by means of the parameter UC04.

Possible **cause 4**

- **CAUSE 4** – Too much or too little pellets in the phase of stabilization. If there is too many or too little pellets, while on the display it says – Stb – i.e. the stabilization, this may cause the blocking of flame and restoring the boiler into the state extinguishing. The quantity of pellets in the stabilization phase is regulated by means of parameter CL04.
- The procedure for **troubleshooting 4** – Set the value of the parameter CL04 to factory default or close to factory adjustment.

Possible **cause 5**

- **CAUSE 5** – The boiler has entered the phase of stabilization but it is going into the extinction phase because there is not a sufficient increase in temperature of flue gases.

Specifically there is the stagnation, i.e. a slight decrease of temperature of flue gases which is visible when re-filling of pellets is done into the furnace.

- The procedure for **troubleshooting 5** – Raise the temperature of flue gases to enter the system of the parameter F18. This way new pellet entering the combustion chamber lowers the temperature of flue gases in a more harder way as the flame is stronger because it had more time until the re-filling of fuel. This problem most frequently occurs when the chimneys are poor in construction or the drought from any other reason is weak.

Possible **cause 6**

- **CAUSE 6** – The boiler has passed the stabilization phase but it is going into modulation, and on the display it says - Nod. If flue gases are checked, at this point, it is distinct that they are too high.
- The procedure for **troubleshooting 6** – Check whether the flap inside the boiler is in the position, „open”. Close the flap, i.e. moving the handle on the side towards the front of the boiler.

Possible **cause 7**

- **CAUSE 7** – The boiler has entered the phase of stabilization, but after a while the fire is extinguished.
- The procedure for **troubleshooting 7** – You forgot to push back the ashes tray into its compartment and to completely close the ash tray.

Group III

Introduction

When the boiler reaches the set temperature of the water in it, or the air in the room, where the room thermostat, turns into a resting phase keeping the flame or, originally said „Standby phase“. best example for this type of boiler is its operation at night.

The main objective of this phase is to maintain the flame or live coals in the firebox during several hours of standby. It is achieved through periodic turning of both the pellet conveyor and fan in certain periods of time.

- At the time when the boiler has reached the set temperature it enters the phase of flame maintenance. After a certain period of time, as determined by the parameter T04 (in minutes) the conveyor starts and fans are activated. During this period it comes to activating of the boiler until it receives the command to start due to the achieved temperature.
- The duration of the process of conveyor and fan operations is determined by the parameter T05 (in seconds).
- During the process of the start of conveyor operation, its work is determined by the active, working period as determined by the parameter CL09 (in seconds) as well as by the the break period specified by parameter CP09 (in seconds).

- During the process of maintaining the flames the fan for primary combustion is switched on with the power which determined by the parameter Uc09.

Possible mistakes in the work related to the maintenance phase of the flame:

- Boiler operation, beside the functioning of the phase of flame maintenance, does not have enough pellets for the start and work in normal mode.
- Eliminating the cause of mistake:
 1. Reduce the parameter T04, i.e. increase the frequency of conveyor and fan work in the phase of idle work.
 2. Increase the duration of the process time, ie. The parameter T05.
- Too much of unburnt pellet when boiler starting its work.
- Eliminating the cause of mistake:
 1. Increase the parameter T04
 2. Reduce the parameter T05
 3. Reduce the fan power for the primary combustion in the maintenance phase – the parameter Uc09.

8.6 Maintenance of boiler

TKAN boiler requires daily and periodic cleaning.

- Daily cleaning refers to the area of the firebox of cast iron where by continuous ash ejection provides a better electric heaters work, a better firewood burning, i.e. a bigger amount of air through air channels in the gray casting. But even during the day the ash begins to accumulate on the floor, and the space around the furnace. The average parameter of 100kg of pellets produce 1 KG of ashes in combustion process.
- In every 3 to 7 days it is necessary to clean the space between the pipe grid for solid fuel. Also it is necessary to clean the deposits on the walls of the firebox. By this we provide a better transfer as one millimeter layer of tar and soot decreases the conductivity by 5%.
- Once in a month it is necessary to open the top cover for cleaning, which slot dimensions 372mm x 285mm for TKAN1.1 and TKAN1.2 also 492mm x 285mm for TKAN2, remove the turbulators and then from the whole area of the boiler the tar and soot should be removed (**figure 18.**). All that is removed in this way, can be collected and taken away through lower openings.

If, during the cleaning in the boiler there appears the condensation it is necessary to collect the condensed matter and the whole boiler inside should be coated by base means for cleaning or else by means of water solution of construction lime. In this way the neutralization of acids is carried out due to condensation.

 ***While maintaining and servicing the boiler, the boiler is to be switched off the power supply.***

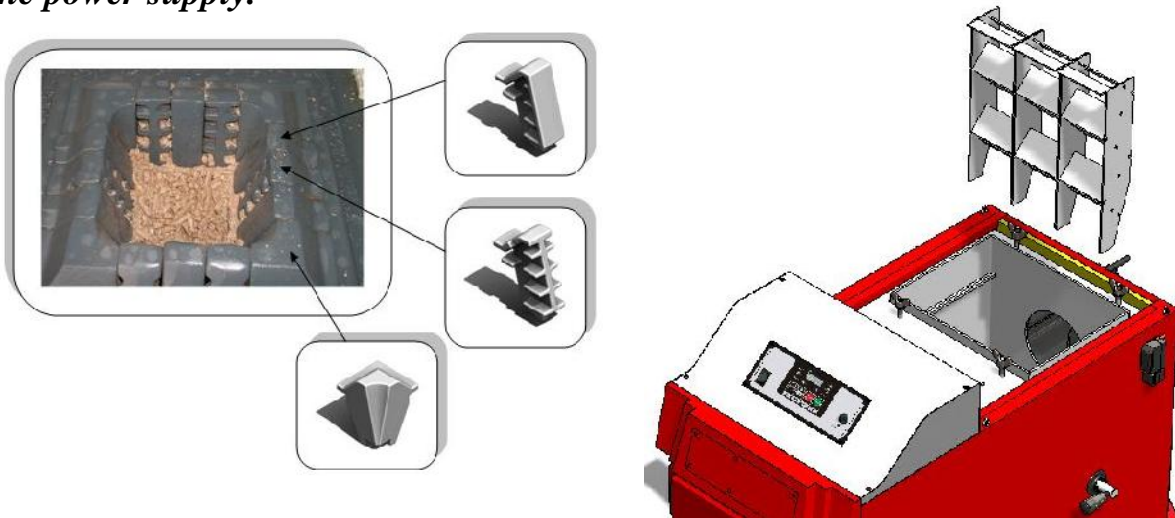



Figure 18. Display removing turbulators from boiler TKAN

 ***In this way the boiler is conserved at the end of the heating season. In this situation, close all openings of the boiler to prevent the circulation of air through the boiler as the moisture can occur in the boiler as well.***

 ***Maintenance of the boiler is one of the most essential factors for the length of working life of the boiler. It is particularly important that the boiler be cleaned when out of operation season and neutralization of acids be done as already described.***

8.7 Nameplate

The nameplate is stuck on a well visible place on the boiler and includes the following (see the image in the item: STICKERS):

1. Technical data on sticker:

- Manufacturer (Radijator inženjering)
- Serial number of boiler (primer: N°:100914118)
- Year of product (primer: 2014)
- Type of boiler (TKAN1.1 or TKAN1.2 or TKAN2)
- Nominal power of boiler (TKAN1.1 – 27kW or TKAN1.2 – 34.9kW or TKAN2 – 49.5kW)
- Heat output range (TKAN1.1 – 8.1–27kW or TKAN1.2 – 8.1–34.9kW or TKAN2 – 14.5-49.5kW)
- Necessary chimney draft (18Pa)
- Electric density (230V)
- Frequency (50Hz)
- Current (3,35A)
- Nominal electrical power (570W)
- Max.extended el.power (200W)
- All.el.power (770W)
- Weight boiler (TKAN1.1-635kg, TKAN1.2-635kg, TKAN2-787kg)
- Class of boiler according to EN 305-5
- Max. pressure (3 bar)
- Max. temperature (90°C)
- Quantity of water in boiler (TKAN1.1 – 97L or TKAN1.2 – 97L or TKAN2 – 125L)
- Class fuel - pellets (C1)

2. Sticker of importer

3. OEEQ

4. Other markings on the boiler



8.8 Declaration



DECLARATION OF CONFORMITY

UNDER THE DIRECTIVE 2006/42/EC ON MACHINERY
ANNEX II, PART 1, SECTION A.

On behalf of "RADIJATOR Inženjering" d.o.o./ Živojina Lazića Solunca 6; 36000
Kraljevo; Serbia

DECLARES

Own responsibility: Heating boiler burning wood/pellet production series TKAN with
rated heating output: TKAN 1.1-27kW and TKAN 1.2-34.9kW and TKAN 2-49.5kW

meet the requirements of: DIRECTIVE 2006/42/EC ON MACHINERY (EFFECTIVE
29/06/2006),

and the requirements of the following directives and regulations:

1. Directive 2004/108/EC of the European Parliament and of the Council of 15 December 2004 on the approximation of the laws of the Member States relating to electromagnetic compatibility (Text with EEA relevance) and repealing Directive 89/336/EEC;
2. Directive 2006/95/EC of the European Parliament and of the Council of 12 December 2006 on the harmonisation of the laws of Member States relating to electrical equipment designed for use within certain voltage limits (codified version) (Text with EEA relevance) and repealed Directive 73/23/EEC.

The machine complies with the following EN introduced harmonized standarts:
EN 303-5:2012,

and the following EN and technical requirements: EN 60730-1.

TYPICAL BOILER TEST TÜV Rheinland/ Paluska Gyula/ H/B1 12 0485.

Location: Kraljevo
Date: 2014-02-07

Signature:  / Miroslav Jamić, general manager /

8.9 Sticker

On the boiler BIOmax there are stickers identifying the connections as well as labels against the risk of electric shock, stickers for scheme of connections etc.

Labels that indicate connection to the installation:

1. Sticker (Hot water) 32mm x 74mm



2. Sticker (Cold water) 32mm x 74mm



3. Sticker (Safety group) 32mm x 74mm

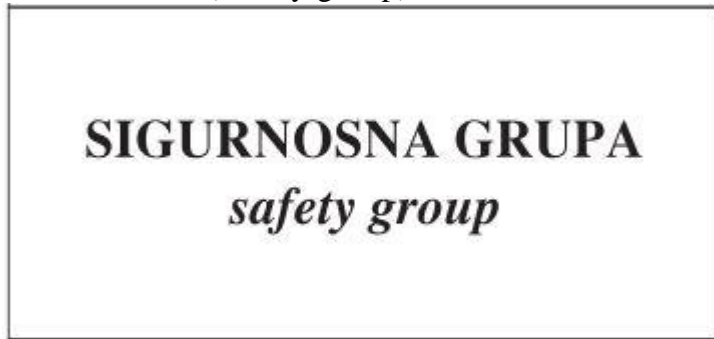

4. Sticker (Cold water inlet/outlet) 32mm x 74mm



5. Sticker (inlet/outlet of thermal safety relief valve) 32mm x 74mm



6. Sticker (Probe of temperature safety relief valve) 32mm x 74mm



8. Sticker (Hydraulic scheme) 152mm x 210mm

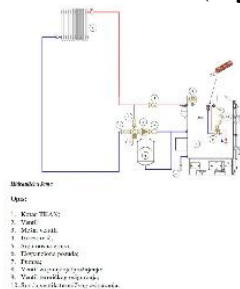

Labels that indicate the presence of electricity high voltage and danger:

1. Sticker (Hazardous voltage) 60mm x 80mm



2. Nalepnica (Input with low voltage 12V) 60mm x 80mm



3. Nalepnica (Hazardous voltage - BIGGER) 100mm x 150mm



4. Sticker (Safety electrical connection) 20mm x 30mm



5. Sticker (Presence of voltage)



Labels that indicate warning:

1. Sticker (Exposed moving parts can cause severe injury) 30mm x 80mm



2. Sticker (Only an approved installer is authorized to start boiler)
65mm x 247mm



3. Sticker (Warning)



5. Sticker (Waste)



Labels with technical data:



Živijina Lazića Solunca br.6
Grdica-36000 Kraljevo
Srbija

N^o 100815092
TKAN 1.1



Živijina Lazića Solunca br.6
Grdica-36000 Kraljevo
Srbija

N^o 100815092
TKAN 1.2



Živijina Lazića Solunca br.6
Grdica-36000 Kraljevo
Srbija
e-mail: radijator@radijator.rs
www.radijator.rs



Pressure max	Temp. max
Max. pritisak	Max. temp.
3 bar/300kPa	90°C

N^o: 100815092
Godina/Year: 2015

PROIZVOĐAČ MANUFACTURER	Radijator Inženjering
TIP - MODEL TYPE - MODEL	TKAN 1.1
NAZIVNA TOPLOTNA SNAGA KOTLA NOMINAL HEAT OUTPUT POWER	27 kW
PODRUČJE UPOTREBE TOPLOTNE SNAGE HEAT OUTPUT RANGE	8.1 - 27 kW
POTREBNA PROMAJA DIMNJAKA REQUIREMENT AIR FLUE	18Pa
ELEKTRIČNI NAPON VOLTAGE	230 V
FREKVENCJA FREQUENCY	50 Hz
JACINA STRUJE CURRENT	3.35 A
NAZIVNA EL. SNAGA NOMINAL ELECTRICAL POWER	570 W
MAX. DODATNA EL. SNAGA MAX. EXTENDED EL. POWER	200 W
UKUPNA EL. SNAGA ALL EL. POWER	770 W
MASA KOTLA MASS OF BOILER	635 Kg
ZAPREMINA VODE U KOTLU VOLUME OF WATER IN THE BOILER	97 L
KLASA KOTLA PO EN 303-5:2012 CLASS OF BOILER ACCORDING TO EN 303-5:2012	5
GORIVO FUEL	C1



Živijina Lazića Solunca br.6
Grdica-36000 Kraljevo
Srbija
e-mail: radijator@radijator.rs
www.radijator.rs



Pressure max	Temp. max
Max. pritisak	Max. temp.
3 bar/300kPa	90°C

N^o: 100815092
Godina/Year: 2015

PROIZVOĐAČ MANUFACTURER	Radijator Inženjering
TIP - MODEL TYPE - MODEL	TKAN 1.2
NAZIVNA TOPLOTNA SNAGA KOTLA NOMINAL HEAT OUTPUT POWER	34.9 kW
PODRUČJE UPOTREBE TOPLOTNE SNAGE HEAT OUTPUT RANGE	8.1 - 34.9 kW
POTREBNA PROMAJA DIMNJAKA REQUIREMENT AIR FLUE	18Pa
ELEKTRIČNI NAPON VOLTAGE	230 V
FREKVENCJA FREQUENCY	50 Hz
JACINA STRUJE CURRENT	3.35 A
NAZIVNA EL. SNAGA NOMINAL ELECTRICAL POWER	570 W
MAX. DODATNA EL. SNAGA MAX. EXTENDED EL. POWER	200 W
UKUPNA EL. SNAGA ALL EL. POWER	770 W
MASA KOTLA MASS OF BOILER	635 Kg
ZAPREMINA VODE U KOTLU VOLUME OF WATER IN THE BOILER	97 L
KLASA KOTLA PO EN 303-5:2012 CLASS OF BOILER ACCORDING TO EN 303-5:2012	5
GORIVO FUEL	C1

8.10 Manufactured



RADIJATOR D.O.O.
 Živojina Lazića Solunca br.6
 36000 Kraljevo, Srbija

Živojina Lazića Solunca br.6
 Grdica-36000 Kraljevo
 Srbija

N^o 100815097

TKAN 2



Živojina Lazića Solunca br.6
 Grdica-36000 Kraljevo
 Srbija
 e-mail: radijator@radijator.rs
 www.radijator.rs



Pressure max	Temp. max
Max. pritisak	Max. temp.
3 bar/300kPa	90°C

N^o: 100815097

Godina/Year: 2015

PROIZVOĐAČ MANUFACTURER	Radijator Inženjering
TIP - MODEL TYPE - MODEL	TKAN 2
NAZIVNA TOPLOTNA SNAGA KOTLA NOMINAL HEAT OUTPUT POWER	49.5 kW
PODRUČJE UPOTREBE TOPLOTNE SNAGE HEAT OUTPUT RANGE	14.5-49.5 kW
POTREBNA PROMAJA DIMNJAKA REQUIREMENT AIR FLUE	18 Pa
ELEKTRIČNI NAPON VOLTAGE	230 V
FREKVENCIJA FREQUENCY	50 Hz
JACINA STRUJE CURRENT	3.35 A
NAZIVNA EL. SNAGA NOMINAL ELECTRICAL POWER	570 W
MAX. DODATNA EL. SNAGA MAX. EXTENDED EL. POWER	200 W
UKUPNA EL. SNAGA ALL EL. POWER	770 W
MASA KOTLA MASS OF BOILER	787 Kg
ZAPREMINA VODE U KOTLU VOLUME OF WATER IN THE BOILER	125 L
KLASA KOTLA PO EN 303-5-2012 CLASS OF BOILER ACCORDING TO EN 303-5-2012	5
GORIVO FUEL	C1

36000 Kraljevo, Živojina Lazića - Solunca br.6, Srbija
 tel. +381 36 399 140, fax. +381 36 399 150, <http://www.radijator.rs>
 e-mail: radijator@radijator.rs

9. Warranty

1. Co."Radiator Engineering" covers different warranty periods for different parts (as specified further on) only if the following conditions of guarantee are fulfilled:

- 1.1. The boiler must be connected to the aforementioned hydraulic schemes of technical instruction , especially pay attention to the safety valves, thermal fuse swelling, mixing valve for protection of the cold portion of boiler or against condensation, the range of work pressure of boiler,r operating temperature of the boiler, the conditions in the boiler room, etc.(see item 7)
- 1.2. The boiler must be connected to the chimney of prescribed cross-section, characteristics of insulation and height. (see item 3.4)
- 1.3. Flue gas outlet from boiler to the chimney must be constructed according to the technical instructions.
- 1.4. The said electrical connections must be done on the boiler according to the technical instructions, particularly this refers to the characteristics of the room thermostat, the characteristics of the power supply, which must be within certain limits.
- 1.5. The user must follow the following instructions on how to use and maintain the boiler. (see item 8)

2. Warranty statement

We herewith declare:

- the product has the prescribed and declared quality properties . We are committed, we will, on the request of the buyer, if he timely submits the Request for the repair within the warranty period, do at any expense all repairs, so that the product will operate in accordance with the declared properties,
- that the product is will operate flawlessly within the warranty period if the instructions for the use, installation and operation are respected,
- that in the warranty period will be ready to remove all product failures and keep in stock all the necessary spare parts,
- **warranty period starts from the DATED OF PURCHASE AND LASTS FOR 60 or 72 MONTHS, from the date of manufacture (the date of manufacture is located on the label on the back of the boiler),**
- **60 MONTHS WARRANTY VALID ONLY IF THE BOILER service regularly by the central service "RADIJATOR INŽINJERING", within the period specified for the same (in text below),**
- **warranty is valid if the warranty card is stamped by the Seller, with the registered date of purchase and the attached Sale Invoice/Bill. IT IS ALSO IMPORTANT TO HAVE THE ORDER FOR COMMISSIONING (certified by the Service).**

3. The Guarantee period of one year applies to the following parts:

- all bearings of the series UCFL,
- electric heaters firing,
- bearings of the cellular security conveyor (valvole),

4. Warranty period of two years applies to the following parts:

- motor gearbox,
- chains fortorque transmission 083,
- lower worm spiral,
- primary air fan,
- secondary air fan,
- probes for flue gases,
- the probe for temperature of boiler water.
- boiler automation system with safety thermostat,
- segments for combustion of cast iron,
- electrical connectors,
- insulating materials on doors and openings for cleaning,
- parts of cellular security conveyor (valvole) which are made of gray and ductile iron castings.

5. Warranty period does not apply:

- if after each heating season the regular servicing is not performed,
- the replacement of parts in the regular annual maintenance in accordance with the instructions,
- when failures are made by the purchaser due to improper handling of the product,
- with mechanical failures made during transport and during use (solid objects),
- if the product is installed improperly, contrary to the regulations in force in that area,
- if it is determined that the hydraulic scheme is not done according to the recommendations of the "Radijator inženjering",
- if the customer was using the product over the declared properties in normal circumstances.

6. Warranty period expires:

- if it is determined that the defects were removed by the unauthorized persons or unauthorized service,
- if at repair the original parts were not built in,
- when the warranty period expires.

7. When Reporting failures it is necessary to give the following information:

- name and type of product,
- the date of purchase,
- factory or workshop of the fireplace,
- A brief description of the fault, or lack of,
- full address of owner and contact telephone number, e-mail.

8. Regular annual service

Regular service is performed at the end of the heating season in the period from 15.4. to 31.8 and charged by the established price list of the Co. " Radiator Engineering". Service procedure by the technical persons performing regular annual service, which are authorized by the manufacturer for this, including the following operations:



NOTE: The Service Provider is in obligation to inspect all of the following parts (from the list) feeder and exchanger, and if it comes to replacing of any parts of the same, the user receives the above-mentioned warranty and guarantee for another 12 months placed on the body of the boiler (exchanger). The warranty can be extended up to 5 years from the date of commissioning. Service and extension of service can be performed by a person sent by the Central Service of the Co. "Radiator engineering ". For not changed parts, after the servicing work, the service guarantee is not valid.

- dismantling silos pellet from pellet conveyor;
- dismantling of pellet conveyor from the boiler;
- disassembly of both chains;
- removal of the segments for the combustion from the furnace and furnace space cleaning beneath segments. Checking of the state of segments and their mutual gap;
- cleaning the space of the tube in furnace in which the lower worm spiral is rotating;
- Lubricating of all bearings, top and bottom screw shaft and checking of their proper operational state. Bearing must not have difficulty in turning or cracks in the in the housing. Contrarily the bearing is replaced. If it is determined that the damage to the bearing is due to intrusion of solid objects into the pellet carrier (due to user's mistake or the manufacturer of pellet mistake), Co. "Radiator Engineering" shall charge value of the bearing. If the damage to the bearing is due to the withdrawal of the flame into the pellet transporter itself for reasons of poorly set parameters when using the boiler, Co. "Radiator Engineering" shall charge the value of the bearing.

- removing the chains on both sides of the shaft of the cellular security conveyor (valvoles) and inspection of the proper condition of the bearings 6004 in the valvoles. If rotating of the bearings is difficult, replace the bearings on both sides. If the damage of the bearings of valvoles is due to intrusion of solid body that is not from the boiler (due to user's mistake or manufacturer's of pellets mistake) Co. "Radijator engineering" shall charge the value of the bearings ;
- check the sharpness of the edges of the rotor;
- remove the probe of the flue gas and clean the layers of sediment;
- check fan;
- check the sealing of the upper and lower doors;
- check the maintenance of the boiler heat exchanger.

GARANTNI LIST / GUARANTEE LIST

Tip kotla / Boiler type

Fabrički broj / Factory No.

Garantni rok / Guarantee period

60 MESECI / 60 MONTHS

**Datum proizvodnje /
Date of manufacture**

**Potpis ovlašćenog lica /
Signature of Authorized person**

pečat / stamp

Prodato u firmi / Company of Sale

Datum prodaje / Date of Sale

Potpis / Signature

pečat / stamp