

Kamin  
na BIOMASU/  
BIOMASS  
boiler heating  
STOVE

*BIOlux 14*



## INSTRUKCIJE/ INSTRUCTION MANUAL

Montaža, korišćenje i održavanje kotla/ Assembly, use and maintenance of heating boiler

## SADRŽAJ:

1. Važna upozorenja;
  - 1.1 Minimalna udaljenost od zapaljivih materijala;
2. Opis **BIOlux 14** kamina;
3. Montaža;
  - 3.1 Opšta upozorenja;
  - 3.2 Mere i uređaji bezbednosti kod **BIOlux 14** kamina;
  - 3.3 Radni prostor i pozicioniranje **BIOlux 14** kamina;
  - 3.4 Montaža **BIOlux 14** kamina na dimnjak;
4. Presek **BIOlux 14** kamina sa opisom elemenata;
5. Šema veze automatike;
6. Tabela sa tehničkim podacima;
7. Hidraulična šema;
8. Start rada **BIOlux 14** kamina i održavanje;
  - 8.1 Displej automatike;
  - 8.2 Kratko uputstvo za upotrebu automatike;
  - 8.3 Start rada **BIOlux 14** kamina;
  - 8.4 Greške prilikom startovanja i u toku rada **BIOlux 14** kamina;
  - 8.5 Održavanje i ispuštanje **BIOlux 14** kamina;
  - 8.6 Natpisna pločica;
  - 8.7 Nalepnice;
  - 8.8 Proizvođač;
9. Garancija.

# 1. Važna upozorenja

## OPŠTA UPOZORENJA

- Nakon uklonjenog pakovanja uveriti se u kompletnost isporuke, i u slučaju nedostataka, obratiti se prodavcu koji je prodao kotao.
- Kotao mora biti upotrebljen isključivo za namenu koju je predvideo proizvođač. Isključuje se bilo kakva odgovornost od strane proizvođača za štetu uzrokovanu osobama, životinjama ili stvarima, u slučaju grešaka pri montaži, regulaciji, održavanju ili nepravilnom korišćenju.
- U slučaju curenje vode isključiti uređaj sa električnog napajanja, zatvoriti napajanje vodom i obavestiti ovlašćeni servis ili ovlašćenog montera.
- Ovo uputstvo je sastavni deo uređaja i mora se čuvati sa pažnjom i mora **UVEK** pratiti uređaj i u slučaju promene vlasnika ili korisnika ili u slučaju priključenja na drugu instalaciju. U slučaju oštećenja ili nestanka tražiti novi primerak od ovlašćenog prodavca.

Pelet kamin je generator toplote koga čini mehanički deo u kome je voda pod pritiskom, ali i dosta elektrokomponenti koje su pod naponom. U ovakvim uređajima gde je mogućnost kontakta vode i elektrokomponenti velika, zahteva se poštovanje sledećih opštih i posebnih sigurnosnih mera:

- Zabranjeno je korišćenje pelet kamina od strane dece i osoba sa ograničenim mogućnostima bez pratnje.
- Zabranjeno je korišćenje pelet kamina na instalacijama sa radnim pritiskom većim od **2.5 bara** i radnom temperaturom većom od **110°C**.
- Ovaj uređaj je proizvođač toplotne energije kako preko vode tako i direktnim putem, emisijom u okolni prostor. Zbog toga postoje površine koje su tako zagrejane da kontaktom mogu da stvore ozbiljne povrede. Prilikom rada sa tim površinama koristiti zaštitna sredstva. Posebno voditi računa da deca ne dolaze u direktni kontakt sa uređajem.
- Zabranjena je bilo kakva intervencija tehničkog lica ili lišćenje od strane korisnika dok se uređaj ne odvoji od mrežnog napajanja izvlačenjem utičnice iz zidnog priključka.
- Zabranjena je izmena sigurnosnih elemenata. Zamenu ovih delova zbog neispravnosti uraditi uz saglasnost ovlašćenog tehničkog lica od strane proizvođača tj. Radijator inženjeringa ili kontaktirati direktno proizvođača.
- Zabranjeno je izlaganje pelet kamina atmosferskim neprilikama. Ovaj uređaj nije predviđen za spoljnu montažu.
- Zabranjeno je isključivanje uređaja ukoliko spoljna temperatura može da padne ispod nule po Celzijusu ( opasnost od smrzavanja ).
- Zabranjeno je stavljanje prstiju i drugih predmeta kroz otvore na spoljnim delovima oplate uređaja. Unutar oplate su elektrokomponente i provodnici pod naponom kao i

ure aji koji se mehani ki pokre u ( motor reduktor i ventilator).Kontakt sa njima može da dovede do strujnog udara i mehani kih povreda.

- Zabranjeno je instalirati ure aj u samoj blizini zapaljivih materijala,naro ito obratiti pažnju na materijal koji izoluje kamin od poda.On mora biti nezapaljiv i odre enih dimenzija.Pogledati odeljak “**Montaža**”.
- Pelet kamin se ne sme prekrivati,niti se na njemu ili uz njega smeju nalaziti bilo kakvi predmeti.
- Za rad pelet kamina potrebno je dovesti svež vazduh(videti u odeljku Montaža).Prostoriju u kojoj se kamin nalazi provetravati više puta u toku dana.
- Zabranjen je istovremeni rad prinudne ventilacije (na primer kuhinjski aspirator) i pelet kamina u istoj prostoriji.Ovo može dovesti do slabog rada ure aja,ali i do curenja ugljenik monoksida koji može da izazove ovekovo gušenje.

### 1.1 Minimalna udaljenost od zapaljivih materijala

- Obezbedite odgovaraju u udaljenost od zapaljivih materijala, ako je potrebno obezbediti zaštitu istih.
- Minimalna udaljenost od zapaljivih materijala je propisana zakonom- molimo da se o tome raspitate kod stru nih lica, koja se bave grejanjem, i dimni ara.
- Minimalna udaljenost kotla i cevi za odvod dimnih gasova od slabo i prose no gorivih materijala treba da bude najmanje 100mm.
- Minimalno rastojanje od lako zapaljivih materijala je 200mm, a isto važi i za materijale ija zapaljivost nije poznata.



#### **Opasnost od požara!**

- Skladištenje zapaljivih materijala i te nosti u blizini kotla je zabranjeno.
- Obavezno upozorite korisnike o potrebnoj minimalnoj udaljenosti zapaljivih materijala od kotla.

<b>Zapaljivost građevinskih materijala</b>	
A ... nezapaljivi	azbest, kamen, građevinski kamen, keramičke zidne ploče, terakota, malter, cementna glazura (bez organskih dodataka)
B ... koji nisu lako zapaljivi	gipsane kartonske ploče, staklena vlakna, ploče od AKUMINA, IZOMINA, RAJOLITA, LIGNOSA, VELOKSA i HERAKLITA
C1 ... slabo gorivi	bukovo i hrastovo drvo, kompozitno drvo, filc, ploče od HOBREKSA, VERZALITA, UMAKARTA
C2 ... prosečno gorivi	drvo bora, tise i jele, kompozitni materijali
C3 ... lako zapaljivi	Asfalt, karton, celulozni materijali, iverica, pluta, poliuretan, polistiren, polipropilen, polietilen, podna vlakna

## 2. Opis *BIOlux* 14 kamina

*BIOlux* 14 kamin je namenjen zagrevanju prostora dvostrukim putem, tj. zagrevanjem vode za radijatorsko grejanje u kotlovskom delu, ali i za grejanje okolnog prostora emisijom toplote preko stakla i zagrejanih površina pre svega dimovodnih kanala koji su ispod kotlovskog dela. Energija koju može da prenese na vodu pri emisiji gasova koja podleže standardu je **10,45 kW**, a emisija u okolni prostor je **1,45 kW**.

Kamin se sastoji iz tri sklopa i je su osnovne komponente obavezne da se isporu uju u standardnoj verziji:

- Kotlovski deo sa turbulatorima, podni deo sa dimovodnim kanalima i spoljna oplata sa vratima koja sadrže staklokerami ku komponentu.
- Displej, plo a automatike, motor reduktor pelet transportera, senzor za vodu u izmenjiva u, senzor temperature dimnih gasova, senzor temperature prostora u kome je kamin i ostala elektro oprema.

Komponente hidro instalacije koje su namontirane na kaminu su: cirkulaciona pumpa, **ekspanzionna posuda od 10 litara**, ventil sigurnosti na pritisak, odzra na slavina.

Drveni peleti su dobijeni od 100% celuloze. Ostaci drveta pod visokim pritiskom su sabijeni u pelet pre nika 6mm i dužine 2-3cm. Pelet treba pravilno skladištiti i to na suvom mestu da bi se obezbedilo efikasno sagorevanje. Kamin *BIOlux* 14 koristi pelet pre nika 6mm, dužine 5-30mm i vlažnosti do 10% izra en po standardu **EN 14962-2**.

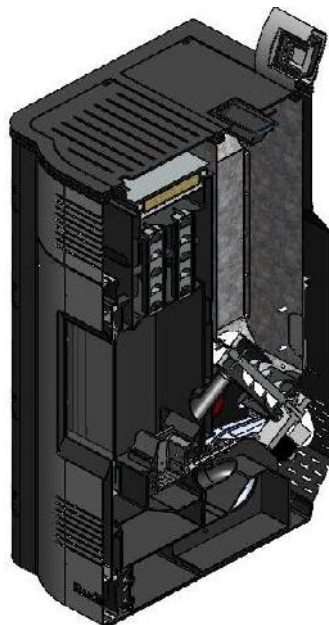

*Slika 1. Popre ni presek **BIOlux** 14 kamina sa elementima*

## 3. Montaža

### 3.1 Opšta upozorenja

**Kamin mora biti pravilno postavljen zbog pravilnog rada!**



**BIOlux 14 kamin je predviđen za rad na instalacijama centralnog grejanja radnog pritiska do 2,5 bara i maksimalne radne temperature 110 stepeni Celzijusa.**



**Vrata na kaminu moraju biti zatvorena za vreme rada kamina.**



**BIOlux 14 kamin je sa ventilatorom, automatikom i motorom i svi uređaji koriste napajanje 230V, tako da nepravilno instaliranje i neoprezno rukovanje mogu da ugroze ljudski život strujnim udarom.**



**Kao gorivo koristiti samo pellet.**



**Pri instaliranju kamina, njegovu težinu uzeti u obzir.**



**Prilikom montaže pridržavati se zakonskih normi i propisa predviđenih za montažu kamina na drveni pelet sa generatorom tople vode, a koji važe u zemlji u kojoj se uređaj montira. U suprotnom Radijator inženjering kao proizvođač ne preuzima odgovornost za posledice takve montaže.**



**Ukoliko neka promena na konstrukciji, naročito na sigurnosnim uređajima dovede do neželjenih posledica koje mogu da naruše vaše zdravlje, pa i život, Radijator inženjering ne preuzima odgovornost.**



**Uređaj mora da radi sa potpuno ispravnim svim sigurnosnim uređajima koji su navedeni i opisani u narednom tekstu. Staklokeramika na vratima i svi dimni kanali moraju da budu bez oštećenja. Sigurnosne uređaje servisirati samo uz konsultaciju sa ovlašćenim licima od strane proizvođača ili kontaktirati direktno proizvođača. U suprotnom Radijator inženjering kao proizvođač ne može da preuzme odgovornost za neželjene posledice.**



**Radijator inženjering, kao proizvođač kotla, ne preuzima nikakvu odgovornost za štete prouzrokovane lošim instaliranjem kotla.**

***\*Sve nacionalne i lokalne regulative i Evropski standard se moraju ispuniti prilikom instalacije kamina.***



### 3.2 Mere i uređaji bezbednosti kod *BIOlux 14* kamina

Za bezbedan rad *BIOlux 14* kamina ugrađeni su sledeći elementi i potrebno ih je održavati ispravnim:

- Ventil sigurnosti na pritisak, odzračni ventili i manometar;
- Elektromehanički presostat za vodu;
- Presostat dimnih gasova;
- Termostati u automatici koja reguliše rad pelet kamina.

**Ventil sigurnosti na pritisak (slika 2), odzračni ventili (slika 3) i manometar (slika 4):**



Slika 2. Sigurnosni ventil



Slika 3. Odzračni ventil



Slika 4. Manometar

- Ventil sigurnosti na pritisak je već fabrički namontiran na pelet kamin i nazivnog je prenika 1/2 col, baždaren na maksimalno 3 bara. Ovaj sigurnosni element koji spada u grupu limitatora pritiska mora da bude takve konstrukcije da izdrži i kratkotrajna prekoračenja i temperature i pritiska, kao i određeni sadržaj glikola u tečnosti za grejanje. Ovaj sigurnosni element mora da podleže i periodičnim ponovnim baždarenjima o čemu investitor tj. korisnik kotla mora da poseduje validnu dokumentaciju.
- Preporučuje se i ugradnja manometra (**slika 4**) na hidrauličkoj instalaciji.
- Ventil sigurnosti mora biti montiran na najvišoj tački kotla i direktno na kotlu bez bilo kakvog cevovoda ili bilo kojih drugih elemenata između. Za ovu svrhu postoji i posebno predviđeni priključak. Strogo je zabranjeno bilo kakvo reduciranje prenika ovog priključka prilikom servisiranja i postavljanje novog ventila sigurnosti.
- Ispusni tj. izduvni deo ventila sigurnosti (ukoliko korisnik želi da je namontira) mora da bude od cevi čiji je prenik najmanje jednak nazivnom preniku ispusnog dela ventila. Tako je dozvoljeno je za njegovu izradu koristiti najviše jedan luk radijusa  $r > 3d$ .
- Sigurnosni ventil mora posedovati nazivnu pločicu i na njoj sledeće podatke:
  - naziv proizvođača;
  - oznaka tipa sigurnosnog ventila/godina ispitivanja;
  - nazivni protok;
  - podatak za koji toplotni učinak je sigurnosni ventil podešen;
  - najviši pritisak otvaranja tj. 3 bara.

- Obavezna je provera ispravnosti rada u određenim vremenskim periodima kao i ponovna baždarenja od strane sertifikovanih firmi. Ove obaveze se sprovode u skladu sa zakonom svake zemlje u kojoj je kotao namontiran. Obavezno čuvati pisani dokument o podacima zadnjeg baždarenja sigurnosnog ventila.
- Na povratnom vodu montirati barem još jedan ventil sigurnosti na pritisak.
- Zajedno sa ventilom sigurnosti na pritisak u istu sigurnosnu grupu spada i odzračni ventil. Na uređaju postoje dva takva ventila. Jedan je na najvišoj tački kotla, a drugi na najvišoj tački sabirnika gde se radi o vodu tople vode i ekspanziona posuda.

#### **Elektro-mehanički presostat za vodu (slika 5):**



*Slika 5. Elektro-mehanički presostat za vodu*

- Ovaj sigurnosni element konstantno meri pritisak u kotlovskom izmenjivaču u pelet kamina i tu informaciju prosleđuje automatici. Ukoliko je pritisak ispod ili iznad vrednosti od 0,5 do 2,7 bara dolazi do prekida rada celog uređaja. Granice vrednosti minimalnog i maksimalnog pritiska određene su programom rada automatike.

#### **Presostat dimnih gasova (slika 6):**



*Slika 6. Presostat dimnih gasova*

- Zadatak ovog sigurnosnog dela je da konstantno meri podpritisak dimnih gasova u delu dimnog kanala gde je priključen i da ovu informaciju prosleđuje automatici. Ukoliko je vrednost podpritiska ispod ili iznad vrednosti koja je unapred definisana u programu



automatike, dolazi do prestanka rada celog uređaja, a na displeju automatike stoji upozorenje da je došlo do greške u radu.



**UPOZORENJE** Do poremećaja podpritiska dimnih gasova može da dođe zbog zapušnosti dimnjaka, veoma velike zaprljanosti dimnih kanala pelet kamina, lošeg zaptivanja vrata ili staklokeramike, poklopaca otvora dimnih kanala itd.

- Ovakvi uslovi mogu da dovedu do lošeg odvođenja produkata sagorevanja, naročito ugljenik monoksida što može u ekstremnim situacijama da dovede do narušavanja zdravlja čak i zagušenja korisnika.

### Termostati u automatici koja reguliše rad pelet kamina (slika 7):

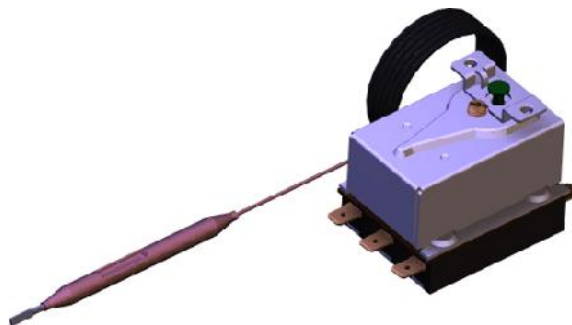

*Slika 7. Termostat na automatici*

U samoj automatici koja vodi proces sagorevanja i utiče na rad dva kruga grejanja postoje dva termostata. Oba su slične konstrukcije kao termostat prikazan na **slici 7.** i imaju i sigurnosne funkcije kao limitatori temp. vode u kotlu. Zbog sigurnosne uloge u funkcionisanju kotla oba termostata imaju nezavisne sonde za merenje temperature vode.

Prvi termostat je tzv. radni i on služi da ograniči temperaturu do nivoa koji želi korisnik. Drugi termostat je sigurnosni jer prekida rad ventilatora koji pospešuje plamen, odnosno dodaje novu energiju. Sigurnosna temperatura je ograničena na 95 stepeni Celzijusa. Ovaj termostat je fizički namontiran pored displeja automatike, ali je strujno vezan sa njom.



**Pumpa za grejanje ima veoma važnu bezbednosnu funkciju i fabrički je povezana sa elektro napajanjem preko automatike i iz sigurnosnih razloga. Kada temp. vode u kotlu dostigne kritičnu vrednost od 95 stepeni Celzijusa ventilator staje sa radom, ali pumpa se obavezno ukljukuje kako bi razmenila toplotu vode kroz radijatore.**



**Montaža slavine za punjenje i pražnjenje se vrši u najnižoj tački sistema. Pošto na samom kaminu ne postoji priključak za punjenje i pražnjenje, slavinu priključiti u najnižoj tački povratnog voda. Instalaciju puniti polako kako bi se sistem dobro ozračio. Tokom punjenja instalacije proveriti da nema curenja u sistemu centralnog grejanja.**

### 3.3 Radni prostor i pozicioniranje *BIOlux* 14 kamina

Prilikom određivanja mesta na kome će se pozicionirati kamin treba voditi računa o sledećim detaljima:

- Kamin mora da bude što bliži dimnjaku, tako i dovod svežeg vazduha za sagorevanje treba da bude što bliže.
- Ako je to moguće kamin treba da bude u najvećoj, centralnoj prostoriji objekta koji se greje zbog što boljeg efekta grejanja zračenjem.
- Uređaj nikad ne sme biti instaliran u spavaćoj sobi niti u prostoriji koju je nemoguće vratima odvojiti od spavaće sobe.
- U prostoriji u kojoj se montira pelet kamin ne sme biti korišćena još neka pelet ili kamin na vrsto gorivo i pelet. Potrebna cirkulacija vazduha kroz jedan od ovih uređaja najverovatnije je da smeta dotoku vazduha u drugi uređaj.
- Prostorija u kojoj je kamin mora da ima mogućnost provetranja i mogućnosti povezivanja sa svežim vazduhom ili sa prostorijom koja je povezana sa spoljnim svežim vazduhom. Ovo povezivanje se ostvaruje sa elastičnim nezapaljivim cevima.
- Za rad uređaja potrebno je mrežno napajanje 230V i 50 Hz. Pozicionirati kamin što bliže priključku i tom prilikom izbegavati produžne kablove.
- U slučaju postavljanja kamina na zapaljivim podlogama (parketi, laminati, tepisi itd.) obavezno izolovati kamin od takve podloge sa pločom od nezapaljivih materijala (glik, keramika, izolacioni materijali od keramičkih vlakana, itd.) Takve ploče treba da su gabarita veća od osnove kamina (**videti sliku 8**).
- Kamin mora biti bezbedno udaljen od lako zapaljivih materijala kao što su drveni i tekstilni delovi nameštaja, zavese, delovi od plastike itd. Udaljenost mora biti barem jedan metar od takvih materijala.
- **Udaljenost kamina od vrstih nepokretnih objekata (zidovi, stubovi, itd.) (slika 8) mora sa bočnih strana biti minimalno 40 cm (slika 7. mera B), sa zadnje strane 20 cm (slika 7. mera C) i sa prednje strane 100 cm (slika 7. mera A). Ova udaljenja su potrebna zbog prilaza otvorima za čišćenje, kao i zbog pristupa prilikom servisnih intervencija.**

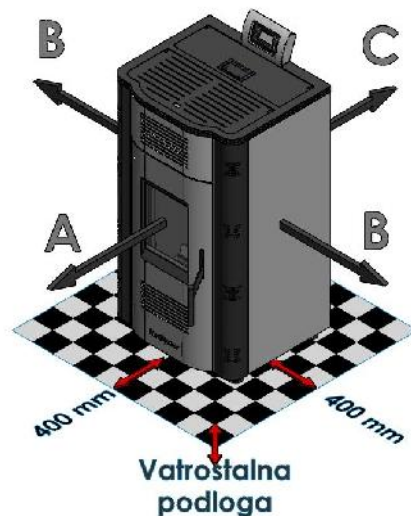

Slika 8. Prikaz udaljenosti kamina od nepokretnih objekata

### 3.4 Montaža *BIOlux* 14 kamina na dimnjak

Prilikom povezivanja pelet kamina sa dimnjakom razlikuju se dve faze montaže i to:

- **Montaža dimovodnih kanala i dovod svežeg vazduha za sagorevanje.**
- **Priključenje na dimnjak.**

#### **Montaža dimovodnih kanala i dovod svežeg vazduha za sagorevanje (slike 9 i 10):**

- Za povezivanje pelet kamina sa dimnjakom mora da se koriste specijalne dimovodne cevi koje imaju sertifikate za ovu namenu. Materijali koji se koriste za izradu ovih cevi su konstrukcioni i nerđajući čelici.
- Prečnik dimovodne cevi mora da bude odgovarajući i prečnik dimnjaka na izlazu, a to je 80mm. Zabranjeno je reducirati ovaj prečnik.
- Dimovod se ne sme koristiti za više od jedne sate istovremeno.
- Prilikom montaže dimovoda dozvoljeno je maksimalno dva skretanja dima od 90 stepeni. Maksimalna dužina horizontalnih deonica dimovoda je 2m.
- Ukoliko je dimovod blizu zapaljivih materijala ili prolazi kroz njih (ukrasni sloj zida) obavezno je izolovati ga.
- Dimovodne cevi i elementi namenjeni za priključenje na kamine za pelet najčešće imaju silikonske O prstenove na mestu spajanja. Ovo treba obavezno proveriti pa ako ih nema unapred ugrađeni koristiti silikon ili neki drugi vatroštalni kit za zaptivanje.
- Dimovod mora biti demontažan kako bi se povremeno proverila njegova zaprljanost ili mora da postoji revizioni otvor.
- Ukoliko odvod dima ne ide direktno u dimnjak već vertikalno uvis, potrebno je ugraditi kondenzacioni T komad.

- Dovod vazduha za sagorevanje mora se dovesti sa spoljne strane (iz okoline) i za to koristiti cev napravljenu od crnog ili inox elika. Najmanji dozvoljeni prenik ove cevi je 50mm.
- Ukoliko nije moguće dovesti vazduh direktno iz spoljne okoline onda mora biti omogućen dovod iz prostora koji je u direktnom kontaktu sa okolinom. Veza takvog prostora sa okolinom mora biti takva da nije moguće slučajno prekinuti dovod vazduha (zatvaranjem vrata, prozora itd).

### **Priključenje na dimnjak (slike 9 i 10)**

Prilikom montaže dimnjaka razlikujemo dve situacije:

- **Situacija 1:** Kamin se priključuje na standardni dimnjak (zidani ili metalni) koji ima svoj temelj i pun presek od temeljne ploče do vrha.
- **Situacija 2:** Kamin se priključuje na montažni metalni dimnjak pričvršćen na fasadu.

#### **Situacija 1:**

- Kao dimnjak koristiti keramičke ili metalne cevi kružnog poprečnog preseka minimalnog prenika 130mm. Dimna cev obavezno mora biti izolovana.
- Ukoliko dimnjak već postoji i kvadratnog je poprečnog preseka, onda su minimalne dimenzije tog preseka 130x130mm.
- Nije dozvoljeno koristiti dimnjak za priključenje više uređaja.
- Nije dozvoljeno koristiti ventilacione otvore kao dimnjak.
- Vrh dimnjaka zaštititi dimnjakom kapom zbog uticaja kiše i vetrova. Rastojanje od kape do dimnjaka 200mm.
- Dimnjak treba da izađe u odnosu na krov prema preporukama sa slike. (**slika 11**) Ukoliko su blizu dimnjaka neki viši objekti uzeti i ovo u obzir i dodatno povećati visinu.
- Dimnjak mora da ima i priključak za izdvajanje kondenza, kao i reviziona vrata. Vrata treba uvek tokom rada dobro da dihtuju.

#### **Situacija 2:**

- U ovoj situaciji dimnovodna cev mora da ide minimalno 1,5 metara vertikalno uvis u samoj prostoriji u kojoj je kamin, a zatim da prođe kroz zid i da se priključi na dimnjak.
- Dimnovodna cev mora da ima T kondenzacioni komad na samom izlasku iz kamina kao i mogućnost demontaže zbog čišćenja.

**UPOZORENJE:** Nepridržavanje pravila tokom izvo enja dimovodnih kanala i dimnjaka može da dovede do nepravilnog rada kamina, ali i do ugrožavanja zdravlja ljudi pa i njihovih života. Najve a opasnost je od otrovnih gasova koji su produkti sagorevanja. U ovakvim situacijama gde nisu dimovod i dimnjak, kao i dovod vazduha za sagorevanje odra eni na na in kako je u uputstvu navedeno, Radijator inženjering ne može da preuzme odgovornost za neželjene posledice.

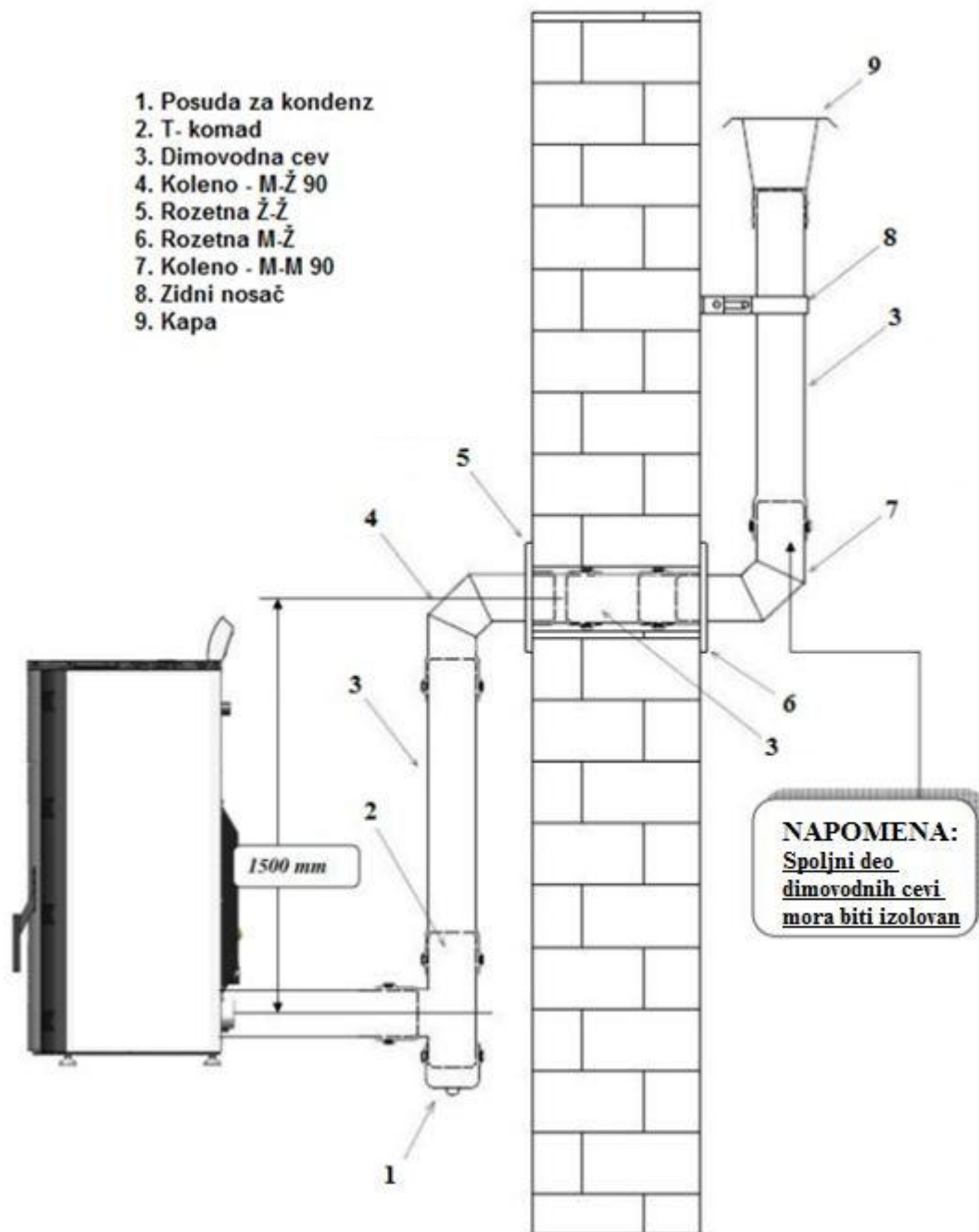

Slika 9. Prikaz montaže dimovodnih kanala

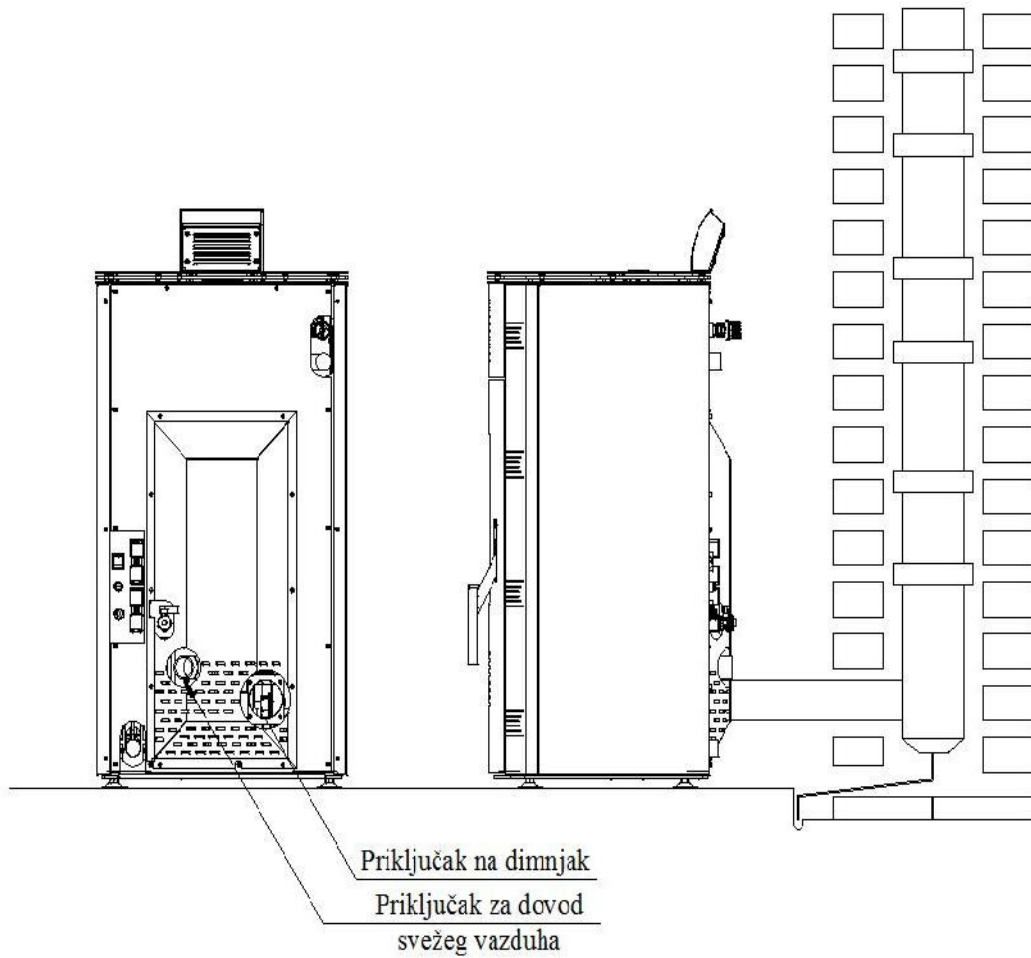

*Slika 10. Prikaz priključenja na dimnjak*



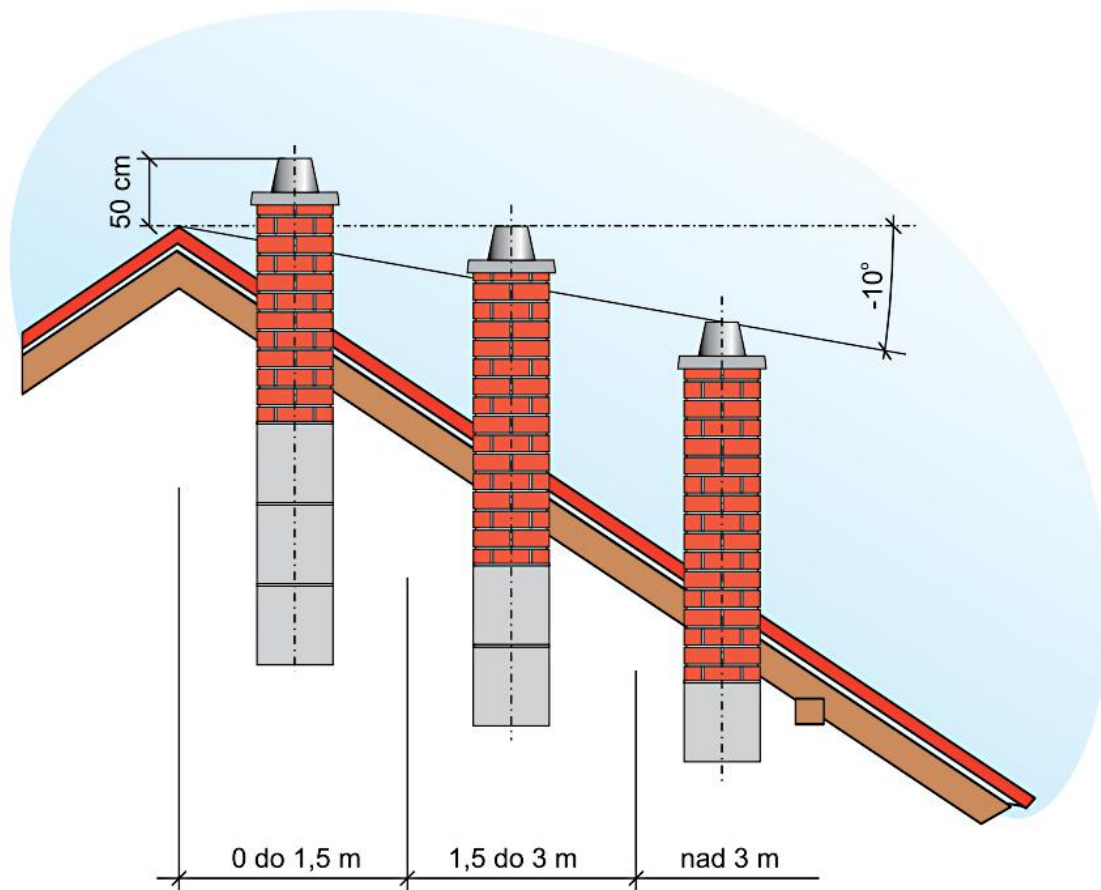

*Slika 11. Prikaz –preporuka gradnje dimnjaka.*



**Preporu uje se iš enje dimnjaka bar jednom godišnje kako bi se smanjio rizik od požara u dimnjaku. Ukoliko do e do požara zaustaviti rad kamina i pozvati vatrogasce.**

#### 4. Presek *BIOlux* 14 kamina sa opisom elemenata

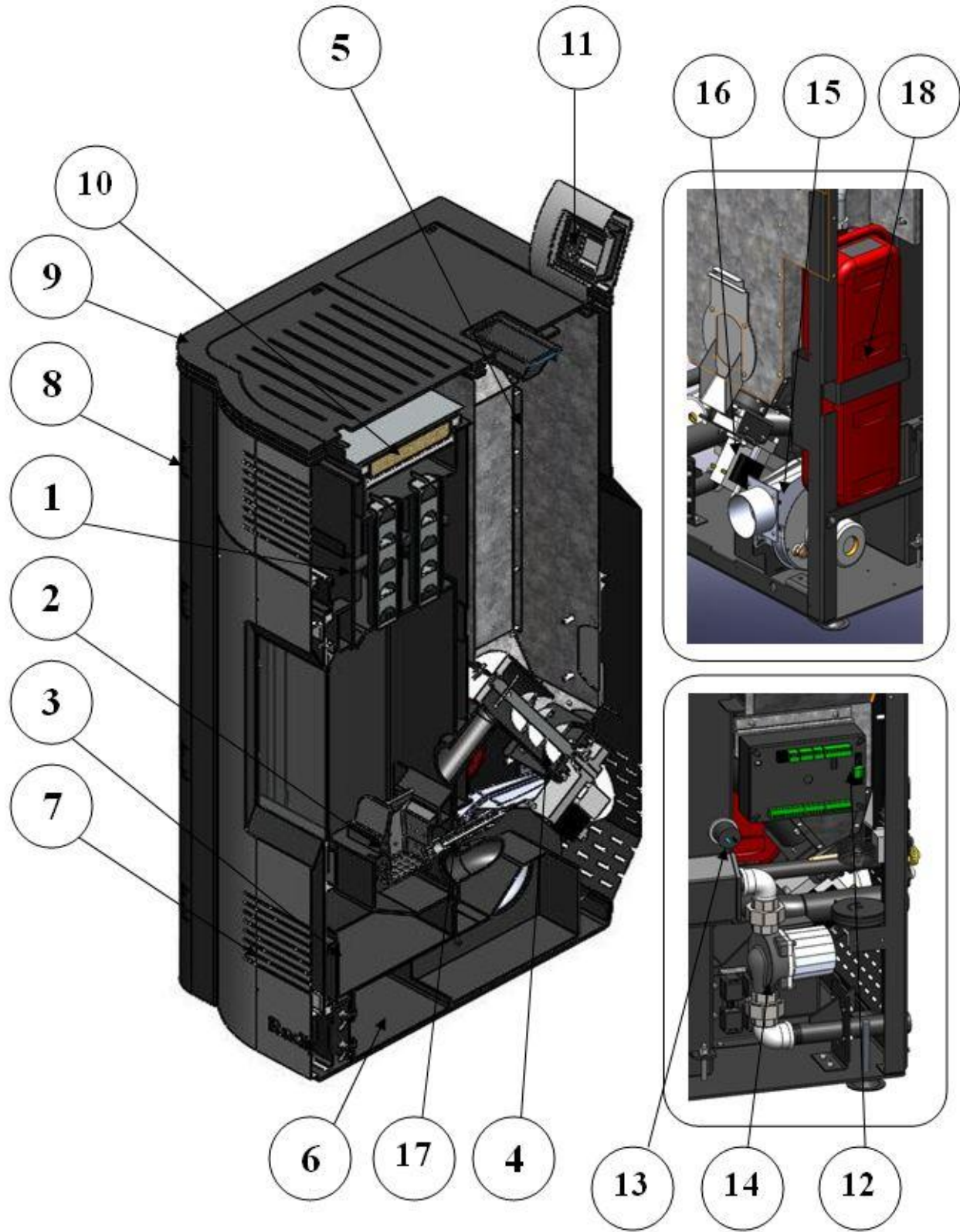

*Slika 12. Presek kamina sa opisom elemenata*

**Opis (slika 12):**

1. Izmenjiva sa turbulatorima;
2. Šolja za sagorevanje;
3. Pepeljara;
4. Dozator;
5. Silos;
6. Dimovodni kanali;
7. Vrata;
8. Oplata;
9. Plotna;
10. Poklopac izmenjiva a;
11. Displej automatike;
12. Procesor automatike;
13. Presostat vode;
14. Pumpa;
15. Ventilator;
16. Motor dozatora;
17. Greja ;
18. Ekspanziona posuda.

## 5. Šema povezivanja automatike

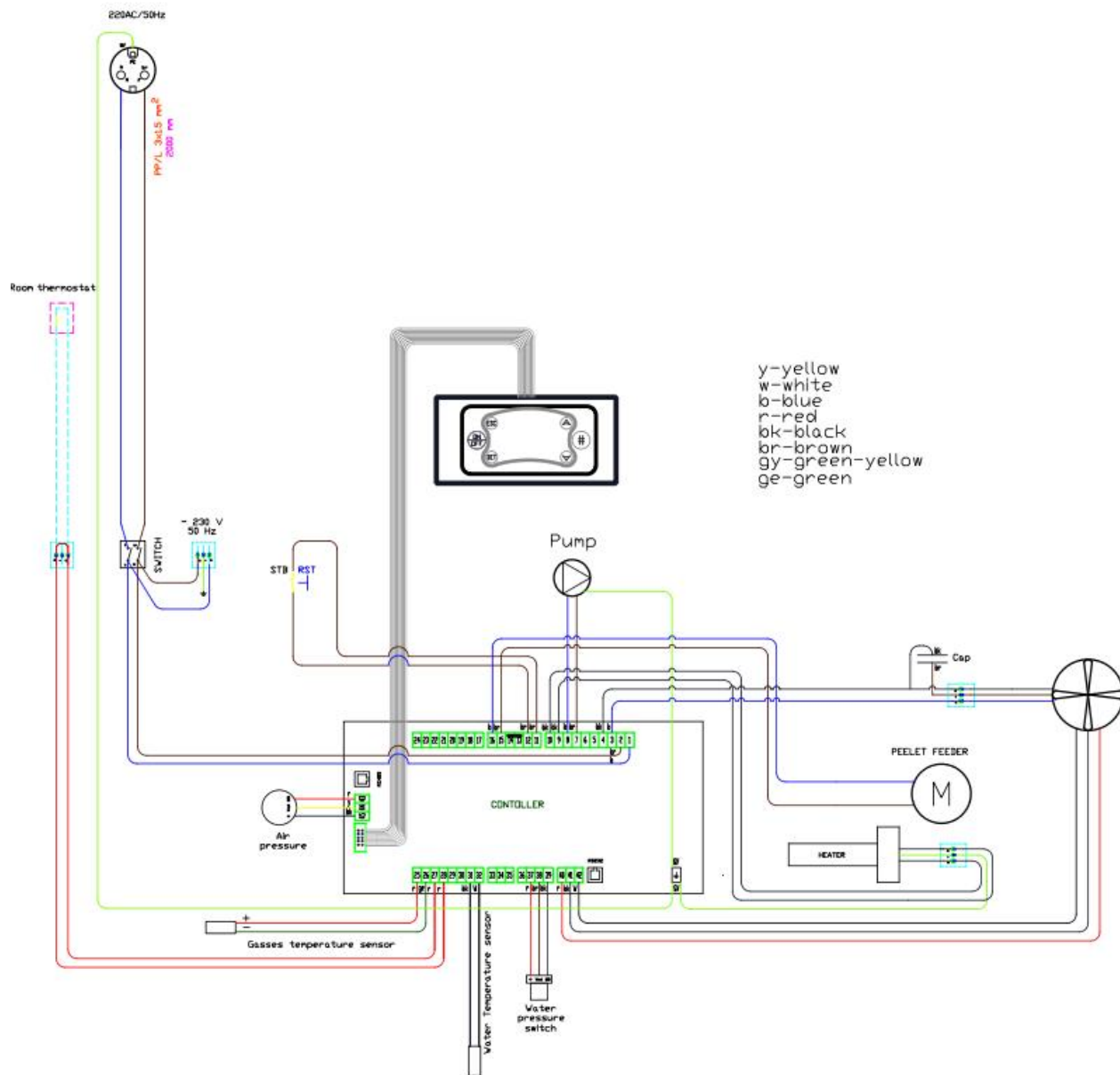

Slika 13. Šema povezivanja automatike

Sve linije koje su prikazane isprekidano na šemi spoljnih priklju enja su provodnici koje je potrebno da instalira tehni ko lice prilikom priklju enja spoljnih ure aja na automatiku kotla. Sva priklju enja dodatnih ure aja tehni ko lice obavlja preko trolnog konektora koja se nalaze na zadnjem delu kotla. Trolni je za priklju enje sobnog termostata što je prikazano na nalepnici samog konektora.



***Za sobne termostate bitno je da budu sa baterijskim napajanjem tj. da nemaju na sebi bilo kakav dovod napona 220 V. Na samom termostatu za povezivanje se koristi NC (normalno zatvoreni kontakt).***

## 6. Tabela sa tehni kim podacima

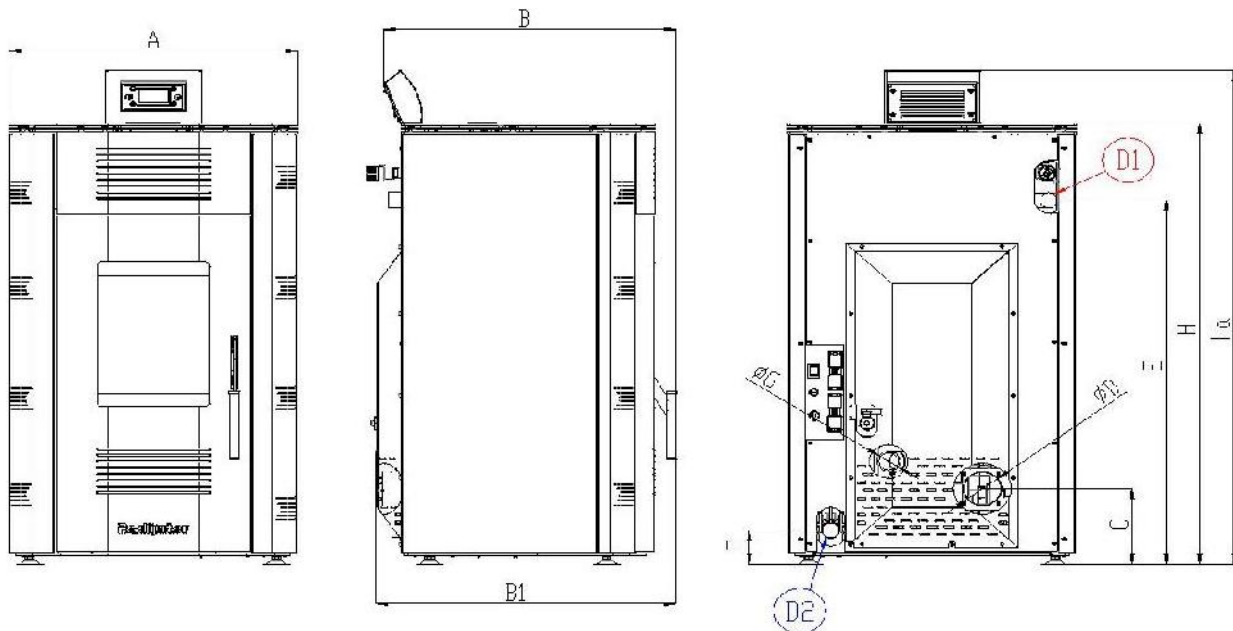

Tip kotla		Mere	BIO Lux 14
Nominalna toplotna snaga		kW	11,90
Snaga u radijatorima			10,45
Snaga u zra enju			1,45
Reducovana toplotna snaga			8,30
Snaga u radijatorima			7,00
Snaga u zra enju			1,30
Emisija CO pri nominalnoj toplotnoj snazi		mg/Nm <sup>3</sup>	160
Emisija CO pri redukovanoj toplotnoj snazi			180
Zapremina vode u kotlu		L-cca	24
Masa kotla		kg	192
Potrebna promaja		Pa	12±2
Max. radni pritisak		bar	2,5
Probni pritisak			5
Max. temperatura potisnog voda		°C	90
Min. temperatura povratnog voda			60
Stepen iskoriš enja		%	>93
DIMENZIJJE	A	mm	600
	B		606
	B1		620
	C		180
	ØD		80
	E		866
	F		81
	ØG		48.3 (6/4")
	H		1050
	Ha		1176
	D1		col
	D2	1"	

### NAPOMENA:

**Priklju ak D1 – potisni vod**  
**Priklju ak D2 – povratni vod**  
**Priklju ak ØG – dovod**  
**vazduha za sagorevanje**

\*Srednja temperatura dimnih gasova pri nominalnoj snazi je 135°C, dok je pri minimalnoj 90°C.



## 7. Hidrauli ka šema

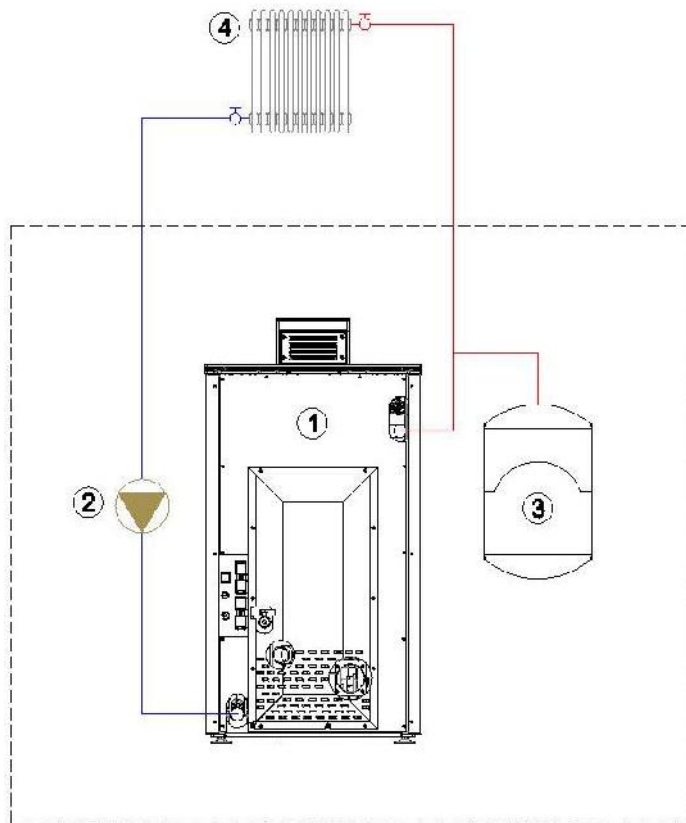

Slika 14. Šema povezivanja

Opis (slika 14):

1. PELET kamin;
2. Pumpa;
3. Ekspanzivna posuda;
4. Radijator (izmenjiva ).

NAPOMENA: U sklopu PELET kamina ulazi i pumpa i ekspanzivna posuda od 10l.

 **Prilikom montaže na hidrauli ku instalaciju kotao mora biti obezbe en na propisan na in od prekora enja *maksimalne radne temperature i pritiska.***

 **Za propisnu montažu odgovoran je instalater *centralnog grejanja koji priklju uje kotao na hidrauli ki sistem.***

 **Radijator inženjering ,kao proizvo a kotla, ne preuzima nikakvu *odgovornost za štete prouzrokovane lošim instaliranjem kotla.***

 **Napomena: Prilikom punjenja hidrauli kog sistema obratiti pažnju na sigurnosne elemente prikazane na slici 15.**

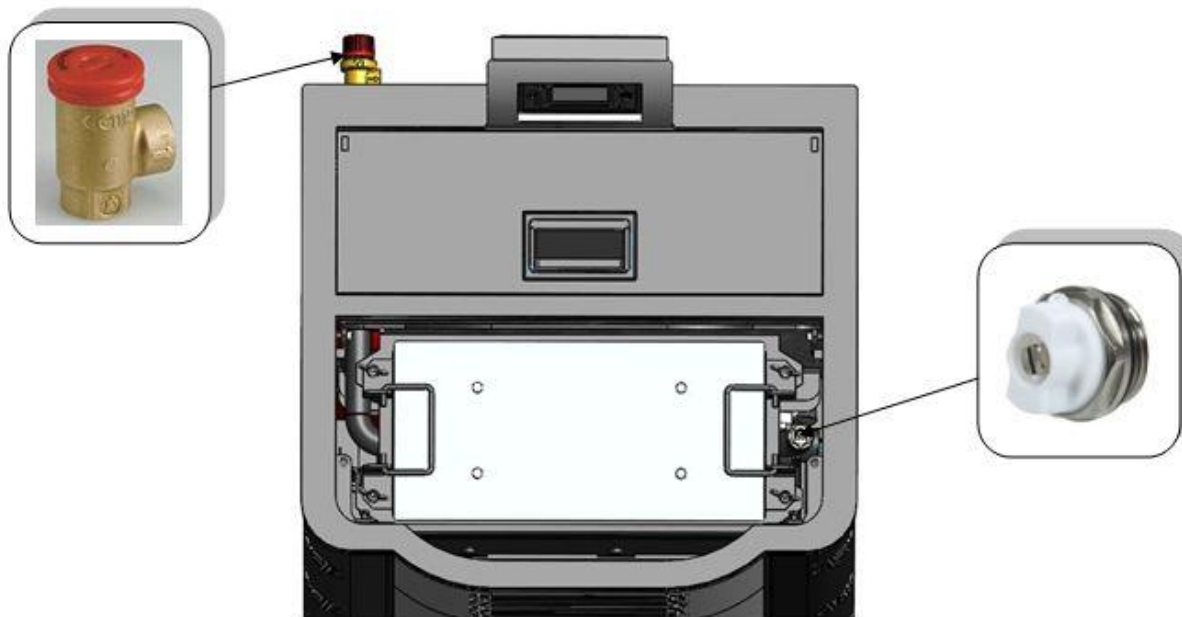

*Slika 15. Prikaz odzračivača i sigurnosnog ventila na gornjoj strani kamina.*

## 8. Start rada *BIOlux* 14 kamina i održavanje

 **Prvo puštanje kotla u rad obavlja tehni ko lice koje ima sertifikat izdat od strane Radijator inženjeringa. Obavezna je obuka korisnika kotla.**

Na taj na in to lice je ovlaš eno da prijavi servisnoj službi u samoj fabrici vreme kada je kotao po eo da radi i u kakvom je stanju kotao bio prilikom prvog paljenja, dok kopiju izveštaja o puštanju kotla u rad zadržava. Garancija i upustvo za upotrebu se daje kupcu. Jedan primerak garancije se šalje proizvo a u. Ako garancija nije ispunjena, ona nije važe a.

Samo kotlovi koji su pušteni u rad od strane ovlaš enog tehni kog lica *podležu* uslovima kompletne garancije od dve godine. *Naredni tekst je namenjen samom korisniku kotla, kao jedna vrsta podsetnika, da ako ugasi kotao (npr. zbog iš enja) bude u stanju da samostalno pokrene kotao.*

 ***Parametri vezani za rad kotla, a koji su dostupni korisniku su na samom displeju. Ostale parametre koji su u tzv. skrivenom meniju ne treba menjati bez saglasnosti tehni kog lica koje je pustilo kotao u rad ili same fabrike.***

## 8.1 Displej automatike

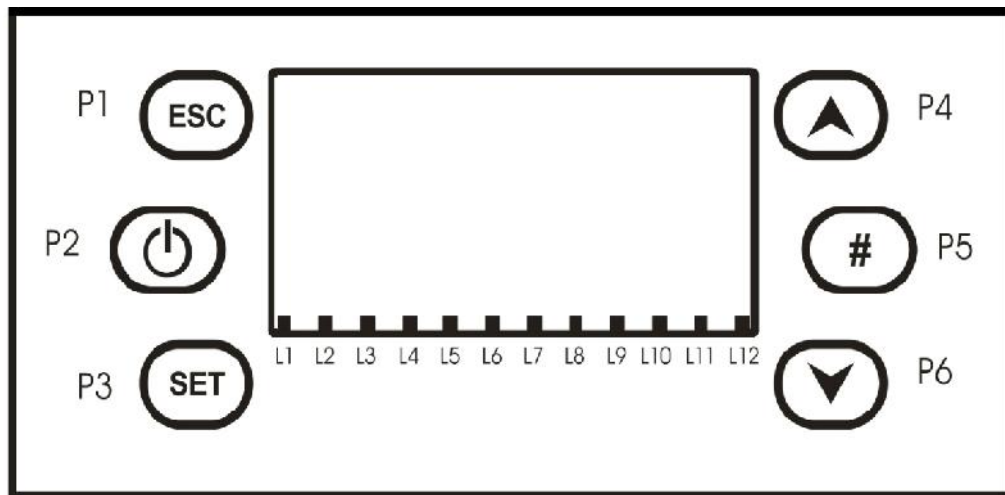

*Slika 16. Slika i šematski prikaz displeja automatike*

**Tasteri:**

Funkcije	Opis	Taster
Uključi/ Isključi	Funkcija paljenja, gašenja pritiskom na dugme 3 sekunde do zvučnog signala.	P2
Odblokirati	Funkcija odblokiranja, kada je sistem u blokadi pritiskom na dugme 3 sekunde do zvučnog signala uklanjate blokadu.	
Izmena vrednosti menija i podmenija	U sistemu izmene promeniti vrednosti u meniju ili podmeniju.	P4 P6
Ulazak u meni ili podmeni	U meniju startovanje podmenija i menija.	
Vizuelizacije	Ulazak i startovanje vizuelnog menija.	
Esc	Funkcija izlaska pritiskom na taster.	P1
Meni	Funkcija ulaska u meni ili podmeni.	
Izmena	Ulazak u sistem izmene u meniju.	P3
Potvrditi	Sačuvati podatke u meniju.	
Resetovanje sistema održavanja 2 funkcije	Resetovanje tajmera T67.	P5

**Diode:**

Funkcije	Opis	Svetleća dioda
Grejač	Dioda uključena: Grejač u funkciji.	L1
Dozator	Dioda uključena: Dozator u funkciji.	L2
Pumpa	Dioda uključena: Pumpa u funkciji.	L3
Mešni ventil	Dioda uključena: Mešni ventil u funkciji.	L4
Izlaz V2 konfigurisan kao sigurnosni ventil peleta ili motor za dopunu peleta ili motor za čišćenje	Dioda uključena: Izlaz V2 u funkciji.	L5
Ventilator za sagorevanje	Dioda uključena: Ventilator za sagorevanje u funkciji.	L6
Izlaz Aux2 konfigurisan kao sigurnosni ventil peleta ili motor za dopunu peleta ili motor za čišćenje	Dioda uključena: Izlaz Aux2 u funkciji.	L7
Nivo peleta	Dioda uključena: Nedostatak peleta.	L10
Spoljni termostat	Dioda uključena: Spoljni termostat u funkciji.	L11
Senzor protoka*	Dioda uključena: Zahtev za sanitarnu vodu.	L12

\* Samo za vodovodne instalacije sa senzorom za merenje protoka



**NAPOMENA: Dioda L4, L5, L6, L7, L10 i L12 nisu u funkciji kod BIOlux 14 kamina.**

## 8.2 Kratko uputstvo za korisnika automatike

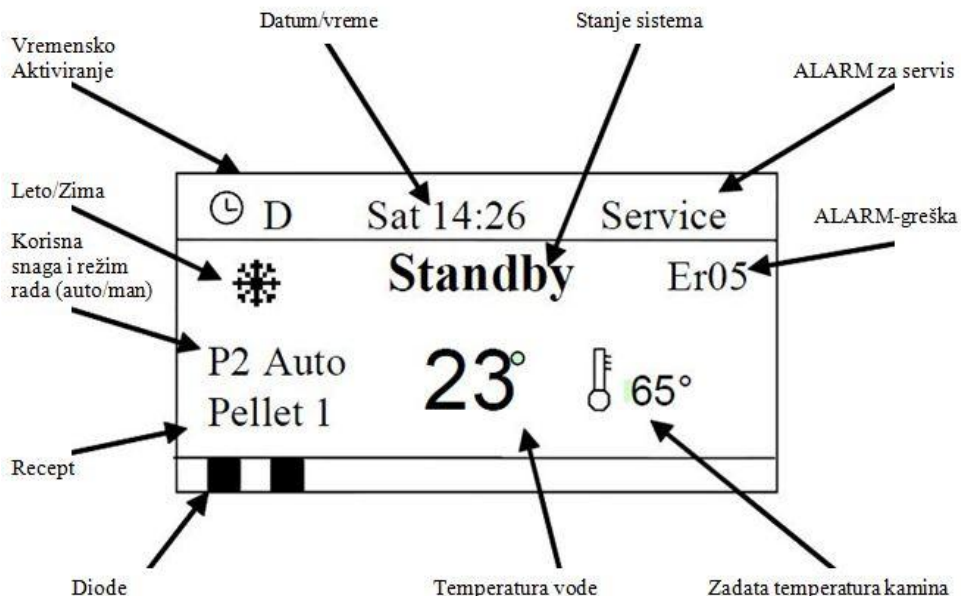

Slika 17. Prikaz LCD ekrana na displeju

- **Očitavanje trenutnog stanja kamina.**

Postupak:



Pritisnuti taster **P6**, nakon toga na ekranu se pojavljuju informacije (slika 18).

<b>Exhaust Temp</b>	<b>103</b>
Boiler Temp	55
Buffer Temp	55
Room Temp	35
Pressure	1548
Air Flow	680
Auger	2.5
Product Code	395 – 0000
FSYSD01000101.0.0	
FSYSF01000131.0.0	

Izduvna temperatura [°C]  
 Temperatura vode u kotlu [°C]  
 Temperatura vode u akumulatoru\* [°C]  
 Sobna temperatura\* [°C]  
 Pritisak [mbar]  
 Protok vazduha\* [cm/s]  
 Vreme rada puža [s]  
 Kod proizvoda

Slika 18. Prikaz stanja kamina na displeju



**NAPOMENA:** Kod kamina **BIO<sub>lux</sub> 14** ne pojavljuju se informacije obeležene zvezdicom



- **Ulazak u MENI automatike i objašnjenje funkcija.**

Postupak:



Pritisnuti taster **P3**, nakon toga na ekranu se pojavljuje padajuća lista (slika 19).

Meni		Opis
<b>Chombustion Power</b>		Meni koji omogućava da izaberete podešenu snagu kamina.
<b>Boiler Thermostat</b>		Meni koji omogućava da promenite zadatu temperaturu kotla.
<b>Chrono</b>	<b>Modality</b>	Meni za izbor programa: Dnevni, Nedeljni, Vikend, Onemogućiti.
	<b>Program</b>	Meni koji dozvoljava podešavanja tri navedena programa: Dnevni, Nedeljni, Vikend.
<b>Recipe</b>		Meni za izbor recepta.
<b>Time and Date</b>		Meni za podešavanje vremena i datuma.
<b>Remote Control</b>		Meni za omogućavanje daljinskog upravljača SYTX.
<b>Calibration</b>		Meni za podešavanje radnog vremena dozatora i brzine ventilatora.
<b>Load</b>		Meni koji omogućava rad dozirnog sistema (prvo i ponovno punjenje prilikom početka rada kotla), ako je sistem u OFF režimu.
<b>Summer-Winter</b>		Meni za odabir zimskog ili letnjeg režima.
<b>Language</b>		Meni za odabir jezika na LCD panelu.
<b>Keyboard Menu</b>		Meni za podešavanje kontrasta i svetla na LCD panelu.
<b>System Menu</b>		Meni za ulaz u sistemski meni.

*Slika 19. Prikaz i objašnjenje MENI automatike*

- **Promeniti podešenu snagu kamina.**

Postupak:



Pritisnuti taster **P3**, nakon toga na ekranu se pojavljuje padajuća lista, gde je i odmah markirana prva opcija **Chombustion Power**. Ponovo potvrditi tasterom **P3**



, nakon toga pojavljuje se prikaz na displeju (slika 19). Tasterima **P4 ili P6**



zadajete podešenu snagu i na kraju ponovo potvrdite tasterom **P3**.



Vratite se na osnovni prikaz displeja (slika 17), pritiskom na taster **P1**



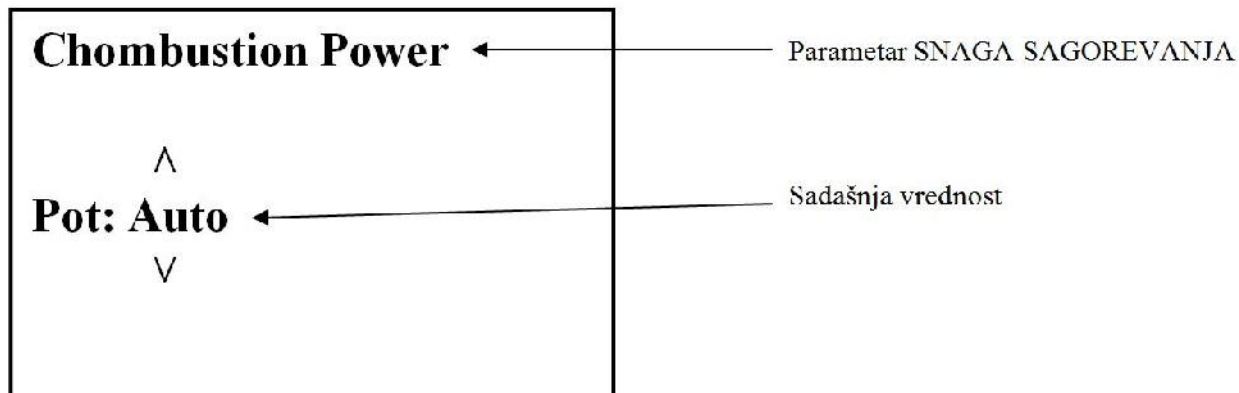









Slika 20. Prikaz i objašnjenje displeja u opciji Chombustion Power



**NAPOMENA:** Kod kamina *BIOlux 14* maksimalna podešena snaga je 3.



- **Promeniti zadatu temperaturu vode u kaminu.**









Postupak:

Pritisnuti taster **P3** , nakon toga na ekranu se pojavljuje padajuća lista, gde je i odmah markirana prva opcija **Chombustion Power**. Tasterima **P4** ili **P6**  , dolazite do opcije **Boiler Thermostat**. Ponovo potvrditi tasterom **P3** , zatim tasterima **P4** ili **P6**   zadajete temperaturu i na kraju ponovo potvrdite tasterom **P3** . Vratite se na osnovni prikaz displeja (**slika 17**), pritiskom na taster **P1** .

- **Promeniti ta no vreme i datum.**

Postupak:

Pritisnuti taster **P3** , nakon toga na ekranu se pojavljuje padajuća lista, gde je i odmah markirana prva opcija **Chombustion Power**. Tasterima **P4** ili **P6**  , dolazite do opcije **Time and Date**.

Ponovo potvrditi tasterom **P3**  pojavljuje se prikaz na displeju **podešavanje vremena i ta nog datuma** gde preko tastera **P4 ili P6**   prelazite sa opcije na opciju a preko tastera **P3**  potvrđujete komandu i menjate joj vrednosti opet preko tastera **P4 ili P6**  . Kada se izabere željena vrednost potvrđuje se tasterom **P3** . Za izlazak i vraćanje korak unazad koristite taster **P1** .

- **Postaviti vremensko programiranje paljenja i gašenja kotla.**  
**(ovu opciju koristite SAMO AKO STE PRETHODNO POSTAVILI TA NO VREME I DATUM)**







Što se vremenskog programiranja tiče, u samoj opciji postoje dve pod opcije, a to su: **Modality** i opcija **Program**.

**Modality** opcija služi za odabir načina programiranja, dakle da li ćete programiranje koristiti na dnevnom nivou, svaki dan posebno (**Daily**) (npr. Ponedeljak, Utorak, Sreda... Nedelja), na nedeljnom nivou (**Weekly**) (od Ponedeljka do Nedelje), i na vikend nivou (**Week-end**) (od Ponedeljka do Petka-posebno i od Subote do nedelje-posebno). Takođe, možete totalno isključiti opciju Chrono (**Disible**).



**Program** opcija služi za programiranje gore navedenih opcija **Daily, Weekly i Week-end**, odn. podešavanje tačnog vremena startovanja i prekida rada kamina.

Postupak:

Najpre, treba odlučiti kako želite programirati vreme puštanje i gašenja, da li će to biti dnevna, nedeljna ili vikend opcija. Ukoliko se odlučite za jednu od navedenih odabir ćete uraditi na sledeći način.

Pritisnuti taster **P3** , nakon toga na ekranu se pojavljuje padajuća lista, gde je i odmah markirana prva opcija **Chombustion Power**. Tasterima **P4 ili P6**  , dolazite do opcije **Chrono**. Ponovo potvrditi tasterom **P3**  (pojavljuju se dve opcije **Modality** i **Program**), zatim tasterima **P4 ili P6**   dolazite do željene

opcije **Modality** i potvrđujete je tasterom **P3** . Nakon toga, u podmeniju nailazite na opcije **Daily**, **Weekly**, **Week-end** i **Disable** (prikazano na slici 21). Tasterima **P4** ili

**P6**   odaberite jednu od njih i potvrdite tasterom **P3** .

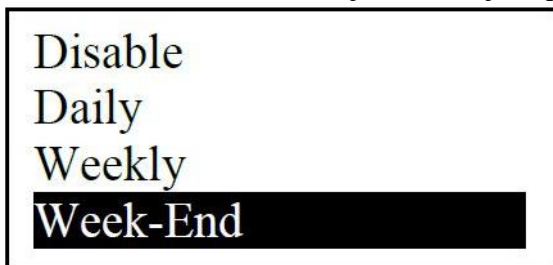

Slika 21. Prikaz displeja nakon odabira opcije MODALITY



Kada ste izabrali način programiranja, automatski se vraćate na prikazu displeja

**Modality** i **Program**. Tasterima **P4** ili **P6**   prelazite na opciju **Program** i

potvrđujete tasterom **P3** .

U ovoj opciji programirate tačno vreme paljenja i gašenja kamina koje ste prethodno odabrali u opciji **Modality**. Primeri programiranja prikazani su na slikama 22,23 i 24.

I dalje za prelazak koristite tastere **P4** ili **P6**  , za potvrdu taster **P3** .

za potvrdu odabrane vrednosti potvrditi tasterom **P5** , i za vraćanje korak unazad taster **P1** .

<b>Daily</b>	<b>Monday</b>	<b>Monday</b>
Weekly	Tuesday	ON OFF
Week-End	Wednesday	09:30 11:15 ✓
	Thursday	00:00 00:00
	Friday	00:00 00:00

Slika 22. Prikaz displeja nakon odabira opcije Daily

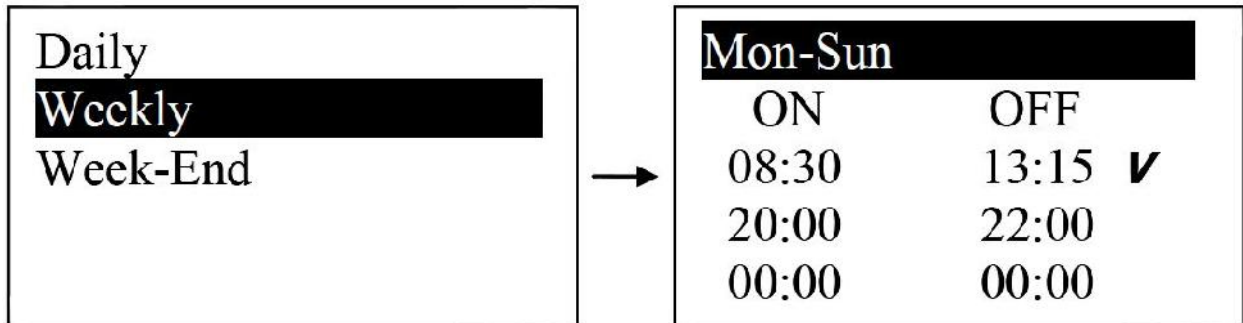

Slika 23. Prikaz displeja nakon odabira opcije Weekly

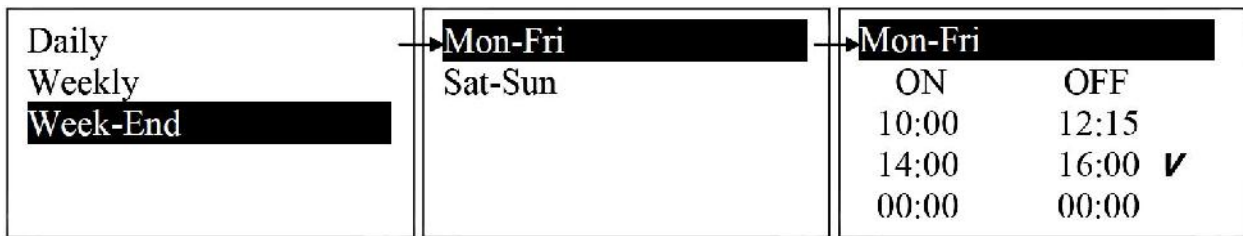

Slika 24. Prikaz displeja nakon odabira opcije Week-end

### 8.3 Start rada *BIOlux* 14 kamina

- **KORAK 1:** Kamin priključen na hidraulički sistem.
- **KORAK 2:** Sipati pelet u silos.

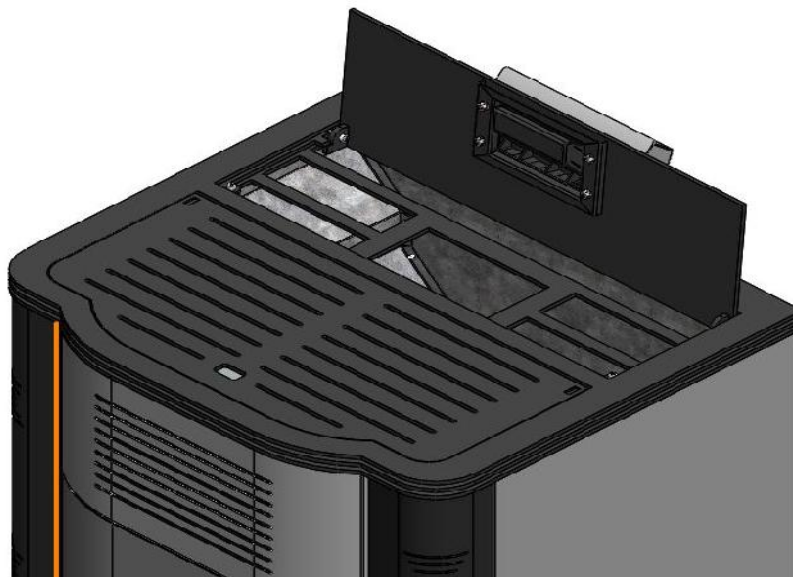

Otvoriti poklopac silosa i sipati pelet u silos.



- **KORAK 3:** Uključiti kamin, prekidač se nalazi sa zadnje strane kamina.

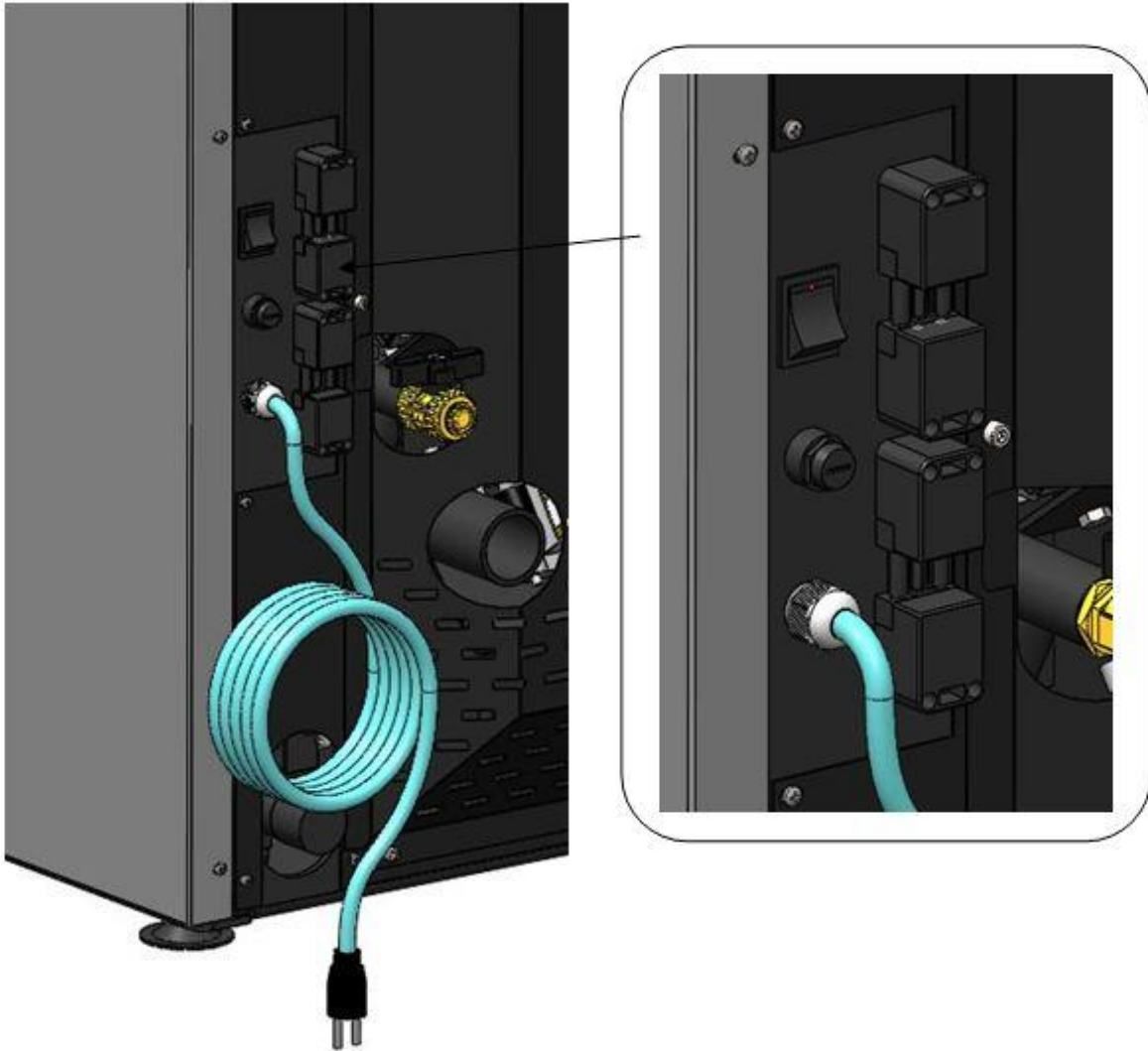











*Slika 25. Prikaz pozicije utikača i glavnog prekidača, kao i sigurnosnog termostata*



**KORAK 4:** Pokrenuti dozirni sistem kako bi prva zrna peleta upala u šolju za sagorevanje. (*Ovaj postupak može se primeniti samo dok je automatika u OFF režimu (slika 17 stanje sistema)*)

Postupak:

Pritisnuti taster **P3** , zatim tasterima **P4 ili P6**   u podmeniju dolazite do funkcije **LOAD**, potvrdite tasterom **P3** , tasterom **P4 ili P6**   pre i sa **OFF** na **ON**, potvrditi sa tasterom **P3** . Potvrdom na taster pokreće se dozer, sve dok prva zrna peleta ne počnu da upadaju u šolju za sagorevanje. Nakon toga, takođe tasterom **P4 ili P6**   prelazite sa **ON** na **OFF**, potvrditi sa tasterom **P3** . Dozator tada staje sa radom. Tasterom **P1**  izađite iz podmenija.

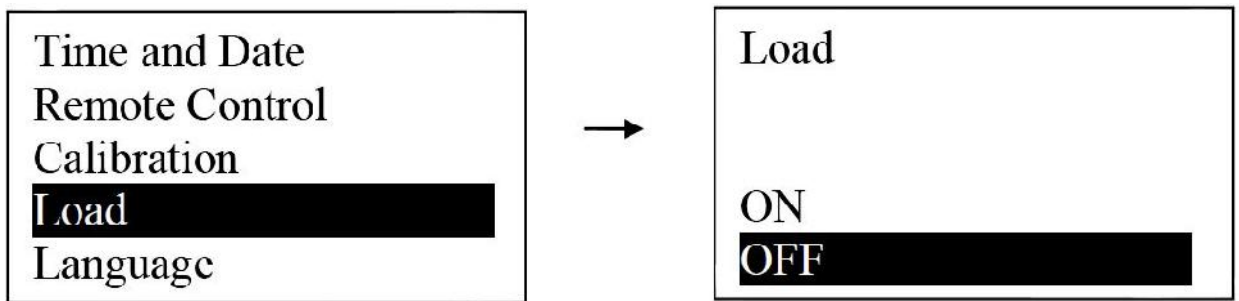

Slika 26. Prikaz displeja prilikom odabira funkcije **LOAD**

- **KORAK 5:** Startovati kamin.

Postupak:

Pritisnite taster **P2** , zadržite 2-3 sekunde do zvučnog signala. Tada na displeju piše „Ignition” (slika 16-stanje sistema). Kotao je krenuo u rad.

U uslovima kada je pelet prema standardima i kada su ispunjeni svi ostali uslovi dimnjaka i protoka vazduha, proces sagorevanje počinje za 5 do 10min.

Prilikom prve potpale treba očekivati nešto pojačanu pojavu dima i oštrih mirisa sve dok fabrički premazi protiv korozije ne završe sa finalnim sušenjem odn. dogorevanjem.

Isti postupak koristimo za gašenje kotla, dakle dužim pritiskom tastera **P2**  do zvučnog signala prelazimo u gašenje kotla.

- Na automatiku može biti povezan sobni termostat. U ovom slučaju, važno je podesiti temperaturu prostorije koja je glavni parametar za rad kamina i temperaturu vode u kaminu (70°C). Kada je aktiviran rad sobnog termostata, kamin najpre ima zahtev za postizanjem temperature sobe, stoga je ograničen zadatom temperaturom vode u njemu. Postoji mogućnost da kamin prestane sa radom pre zadate temperature sobnog termostata, u ovom slučaju treba podići zadatu temperaturu vode u kaminu npr. 70°C.

**Upozorenje: Obavezno izvršiti analizu dimnih gasova nakon završetka instalacije kotla. Izmeriti procenat kiseonika (O<sub>2</sub>).**

#### 8.4 Greške prilikom startovanja i u toku rada *BIOlux* 14 kamina.

Sve moguće greške u početnoj fazi rada tj. prilikom potpale mogu se pojaviti i u samom radu automatika prijavljuju se na displeju. (slika 17-ALARM greška).

Oznake grešaka i objašnjenja prikazane su u sledećoj tabeli.

<b>Er01</b>	<b>Greška</b> - pažljivo visoki napon 1. Takođe i sa isključenim sistemom
<b>Er02</b>	<b>Greška</b> - pažljivo visoki napon 2. Samo ako je ventilator uključen
<b>Er03</b>	<b>Greška</b> - Gašenje kada je temperatura dimovodnih gasova ispod predviđene.
<b>Er04</b>	<b>Greška</b> - Gašenje kada je temperatura vode iznad zadate.
<b>Er05</b>	<b>Greška</b> - Gašenje kada je temperatura dimovodnih gasova preko predviđene.
<b>Er07</b>	<b>Greška</b> - kodera. Ova greška se javlja zbog nedostatka signala kodera
<b>Er08</b>	<b>Greška</b> - kodera. Ova greška se javlja u slučaju prilagodjavanja problema na brojaču
<b>Er09</b>	<b>Greška</b> - Slab pritisak vode
<b>Er10</b>	<b>Greška</b> - Visok pritisak vode
<b>Er11</b>	<b>Greška</b> - pravog vremena na satu
<b>Er12</b>	<b>Greška</b> - Gašenjene nije uspelo zbog potpale
<b>Er15</b>	<b>Greška</b> - Nedostatak napona
<b>Er17</b>	<b>Greška</b> - na regulatoru protoka vazduha
<b>Er18</b>	<b>Greška</b> - Nedostatak peleta
<b>Er39</b>	<b>Greška</b> - Pokvaren senzor regulatora protoka vazduha
<b>Er41</b>	<b>Greška</b> – Nije postignut minimalni protok vazduha
<b>Er42</b>	<b>Greška</b> - Maksimalni protok vazduha iznad predviđenog.

Svi mogući problemi i zastoji u radu ovog uređaja mogu se podeliti u dve velike grupe.

- **Grupa I.** Zastoj u radu prilikom prve potpale i to prve potpale uopšte posle kupovine kotla ili prvog kretanja u rad u toku dana.
- **Grupa II.** Zastoj koji se javlja kad je kotao već bio u radnom procesu, na displeju je postojalo obaveštenje (Run Mode), ali posle dostizanja zadate temperature i mirovanja gubi kontinuitet sagorevanja.

## Grupa I

Naj eš a signalizacija na displeju vezana za ovu vrstu grešaka je **Er12**.

Prilikom prve potpale po ugradnji kotla na hidro instalaciju treba slediti uputstva iz odeljka "Start rada kamina".

Naro ito obratiti pažnju na dimovod (pre nik, broj lukova, dihtovanje, ...), kao i na dimnjak (pre nik, visina, izolovanost, dihtovanje revizionih otvora, zaprljanost dimnjaka, itd.).

Ako posle prvog pokušaja paljenja nema zna ajne pojave plamena i ozbiljnijeg porasta temperature dimnih gasova, na displeju se javlja signal da je greja potpale aktiviran, a ipak kotao ide u fazu gašenja (Extingushing). U ovom slu aju treba proveriti slede e uzroke:

Mogu **uzrok 1**.

- **PROBLEM 1.** Loš kvalitet peleta. Pelet male snage, pove ane vlažnosti.
- Postupak za rešavanje **PROBLEMA 1.** Uzeti pelet proverenog kvaliteta i probati.

Mogu **uzrok 2**.

- **PROBLEM 2.** Temperatura vazduha (koji je doveden kaminu za sagorevanje i potpalu) je izuzetno niska (ispod nule).
- Postupak za rešavanje **PROBLEMA 2.** Podizanje vremena predgrevanja greja a za potpalu, t02, na vrednost 30 – 40 sekundi.

Mogu **uzrok 3**.

- **PROBLEM 3.** Mrežni napon na koji je priklju en kotao je znatno manji od 220-230V, tako da je i snaga greja a manja.
- Postupak za rešavanje **PROBLEMA 3.** Podizanje vremena predgrevanja greja a za potpalu, t02, na vrednost 30 – 40 sekundi. Ako ova mera ne daje rezultate onda priklju iti mrežni ispravlja napona.

Mogu **uzrok 4**.

- **PROBLEM 4.** Koli ina peleta u komori za sagorevanje je nedovoljna za kretanje kotla u rad.
- Postupak za rešavanje **PROBLEMA 4.** Mogu i su mehani ki problemi sa pelet transporterom. Proveriti ispravnost dozatora.

Mogu **uzrok 5**.

- **PROBLEM 5.** Postoje situacije u kojima do e do plamena, ali proverom dimnih gasova jasno se vidi da nema dovoljno peleta da kotao pre e iz faze stabilizacije (Stabilization) u

radni režim (Run mode). Do ovakve pojave dolazi jer je struktura peleta (dužina, lepljivost, količina prašine, itd.) takva da vreme fiksnog nalaganja t03 nije dovoljno.

- Postupak za rešavanje **PROBLEMA 5**. Ovaj problem se otklanja produžavanjem vremena fiksnog nalaganja, t03. Preporuka da se ovo vreme produžava oprezno, prvo za desetak, petnaest sekundi, pa ako i to nije dovoljno onda za još pet itd. Posle toga rešavanje problema kombinovati sa postupkom iz sledeće tačke.

Mogući **uzrok 6**.

- **PROBLEM 6**. Posle faze fiksnog nalaganja (t03) dolazi do uspostavljanja plamena, ali u ovoj fazi t04, za vreme trajanja ovog perioda nije moguće preći u stabilizaciju (Stabilization), pa plamen postaje sve slabiji tako da dolazi do pada temperature dimnih gasova i gašenja (Extinguishing). Do ovog problema dolazi zbog različitog kvaliteta peleta.
- Postupak za rešavanje **PROBLEMA 6**. Smanjiti vreme t04. Preporuka je da to radite oprezno. Moguće je ovaj postupak kombinovati sa rešenjem iz prethodne tačke.

Mogući **uzrok 7**.

- **PROBLEM 7**. Kotao je povezan sa sobnim termostatom. Povećanjem zadate temperature na sobnom termostatu ne dolazi do kretanja kotla u fazu potpale (Ignition) i ne dolazi do aktiviranja grejača za potpalu.
- Postupak za rešavanje **PROBLEMA 7**. Proveriti da li je temperatura u sobi zaista manja od zadate. Takođe proveriti vremensko programiranje sobnog termostata i na kraju proveriti ispravnost sobnog termostata.

## Grupa II

Najčešća signalizacija na displeju vezana za ovu vrstu grešaka je **Er03**.

Mogući **uzrok 1**.

- **PROBLEM 1**. Kamin je potpalio, bio u radnom režimu (Run mode), ali je došlo do zastoja kad je stao pa ponovo dobio zahtev za radom ili od kotlovskog termostata ili sobnog termostata. Komora za sagorevanje je u takvim situacijama puna nesagorelog peleta.
- Postupak za rešavanje **PROBLEMA 1**. Proveriti vrednosti parametara A26, Th28 i Th06. Možda je došlo do menjanja njihovih vrednosti slučajno. Parametar A26 treba da bude 1, parametar Th06 od 60 do 65, dok parametar Th 28 u svakom slučaju barem za dva stepena manji od Th06. U ovakvim slučajevima treba promeniti parametre, isprazniti komoru (šolju za sagorevanje) i startovati ponovo kotao.

Mogu **uzrok 2.**

- **PROBLEM 2.** Kamin je potpalio, ušao u radni režim (Run mode), ali vremenom dolazi do sve veće nagomilavanja peleta po dnu komore za sagorevanje. Vremenom nesagoreli pelet popunjava komoru za sagorevanje i dolazi do smanjenja plamena i odlaska kotla u gašenje (Extingushing).
- Postupak za rešavanje **PROBLEMA 2.** Povećati snagu ventilatora. Najbolje je povećati snagu ventilatora u svim režimima i to preko funkcije kalibracije (Calibration- Exhaust fan).

Mogu **uzrok 3.**

- **PROBLEM 3.** Kamin radi, ali u toku rada dolazi do zastoja i signalizacije na displeju Modulation, a zatim i sigurnosnog gašenja (Extingishing). Na kraju displej signalizira grešku Er05.
- Postupak za rešavanje **PROBLEMA 3.** Do ovoga dolazi jer su dimni gasovi prevelikih temperatura. Najčešći razlozi su zaprljanost kamina, prejak dimnjak, prejak ventilator u radnom režimu, preveliko nalaganje peleta, karakteristike peleta, itd. Zastoj je moguće otkloniti prilagodbom nekog od parametara ili povećanjem parametara za odlazak kotla u modulaciju i sigurnosno gašenje zbog dimnih gasova, a to su parametri Th07, Th08.

## 8.5 Održavanje i isušavanje *BIO.lux* 14 kamina

Kamin *BIO.lux* 14 zahteva svakodnevno i periodično isušavanje.

- Svakodnevno isušavanje se odnosi na prostor samog ložišta, odnosno šolje za sagorevanje, gde stalnim izbacivanjem pepela omogućavamo bolji rad elektro grejača za potpalu i bolje sagorevanje tj. veću količinu vazduha kroz proreze na šolji. Tako će pepeo već u toku dana počinje da se taloži na podu, prostoru oko samog ložišta. Pri prosečnim parametrima sagorevanja 100kg peleta proizvede 1kg pepela.
- Na svakih 3 do 4 dana potrebno je oistiti naslage na zidovima samog ložišta. Ovim dobijamo bolji stepen prenosa jer jedan milimetar naslaga katrana i sa smanjuje provodnost za 5%.
- Jednom u dve nedelje potrebno je otvoriti i gornji poklopac za isušavanje, izvaditi turbulatore i sa celog tada dostupnog dela kotla skinuti katran i sa (slika 27). Sve što se tada skine pokupi se kroz samo ložište. Tako će u tom periodu treba otvoriti prednji revizioni poklopac dimovodnih kanala, koje isto tako treba oistiti od naslaga i sa i katrana kao i od samog pepela.

Ukoliko se u kaminu, tokom korišćenja javi kondenzacija, potrebno je pokupiti kondenzat, a ceo kamin iznutra premazati baznim sredstvima za isušavanje ili barem vodenim rastvorom grafitnog krečnina. Na taj način se vrši neutralizacija kiselina usled kondenzacije.



**Pri održavanju i servisiranju kotla, kotao isključiti sa napajanja.**

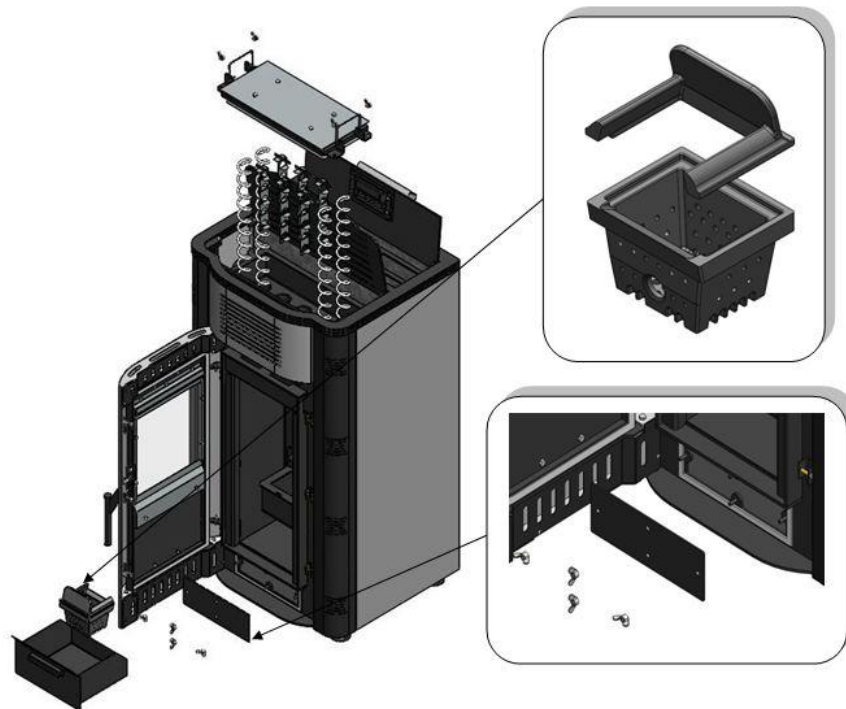

Slika 27. Prikaz elemenata koji se rasklapaju prilikom isušavanja





**Na ovaj način obavezno konzervirati kotao na kraju grejne sezone. U toj situaciji zatvoriti i sve otvore na kotlu da ne dođe do cirkulacije vazduha kroz kotao jer i tako može doći do pojave vlage u kotlu.**



**Održavanje kotla je jedan od najbitnijih faktora za dužinu radnog veka kotla. Naročito je bitno da u vansezoni kotao bude očišćen i da se izvrši neutralizacija kiselina na vešće opisan način.**

## 8.6 Natpisna ploča

Natpisna ploča je nalepljena na dobro vidljivo mesto na kaminu i sadrži sledeće (videti sliku u tački NALEPNICE):

1. Tehnički podaci sa nalepnice:

- Proizvođa (Radijator inženjering)
- Serijski broj kotla (primer: N°:170616003)
- Godina proizvodnje (primer: 2016)
- Tip kotla (**BIO<sub>lux</sub> 14**)
- Nominalna toplotna snaga (11,90kW)
- Snaga u radiatorima (10,45kW)
- Snaga u zračenje (1,45kW)
- Redukovana toplotna snaga (8,30kW)
- Snaga u radiatorima (7,00kW)
- Snaga u zračenje (1,30kW)
- Emisija CO (Nominalna - 160mg/Nm<sup>3</sup>, Redukovana - 180mg/Nm<sup>3</sup>)
- Stepen korisnosti ( Nominalna - 93%, Redukovana - 94%)
- Radni pritisak (2,5bar)
- Električni napon (230V)
- Frekvencija (50Hz)
- Nominalna el. snaga (500W)
- Gorivo (Pelet - C1)

2. Nalepnica uvoznika

3. OEEO

4. Ostale oznake na kotlu



## 8.7 Nalepnica

Na kaminu se nalaze nalepnice za označavanje priključaka kao i nalepnice za opasnost od strujnog udara, nalepnice za šemu povezivanja i dr.

### Nalepnice koje označavaju priključke za povezivanje instalacije:

1. Nalepnica (Potisni vod) 32mm x 74mm



2. Nalepnica (Povratni vod) 32mm x 74mm



### 3. Nalepnica (Šema povezivanja) 148mm x 210mm

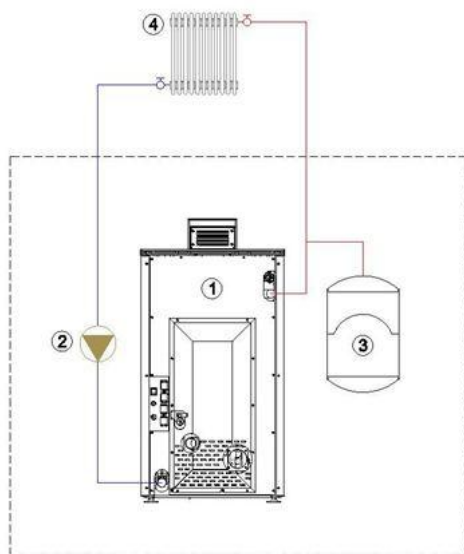

Slika 14. Šema povezivanja

Opis (slika 14):

1. PELET kamin;
2. Pumpa;
3. Ekspanzivna posuda;
4. Radijator (izmenjivač).

NAPOMENA: U sklopu PELET kamina ulazi i pumpa i ekspanzivna posuda od 10l.

### **Nalepnice koje označavaju prisustvo struje, visokog napona i opasnosti:**

#### 1. Nalepnica (Ulaz za sniženim naponom 12V) 60mm x 80mm



2. Nalepnica (Napon opasan po život - VE A) 100mm x 150mm

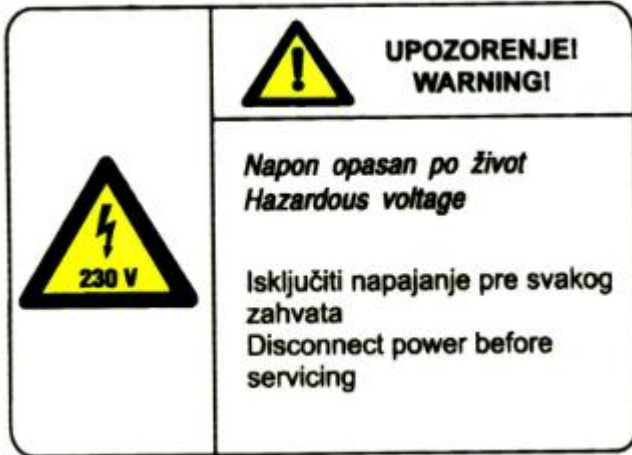

3. Nalepnica (Uzemljenje) 20mm x 30mm



4. Nalepnica (Prisustvo napona)



**Nalepnice koje označavaju upozorenje:**

1. Nalepnica (Izloženi pokretni delovi mogu izazvati povrede) 30mm x 80mm



2. Nalepnica (Obavezno poštovanje u rad od strane ovlašćenog servisa) 65mm x 247mm

**OBAVEZNO PUŠTANJE U RAD OD STRANE**



**OVLAŠĆENOG SERVISERA!**

*only an approved installer  
is authorized to start boiler*



3. Nalepnica (Pažnja)



4. Nalepnica (Otpad)





Nalepnice sa tehni kim podacima:



N<sup>o</sup> 170616003

*BIOlux 14*



*BIOlux 14*

N<sup>o</sup>170616003  
Godina/Year: 2016

Nominalna toplotna snaga/Nominal heat output	11.90 kW
Snaga u radiatorima/Heat output water	10.45 kW
Snaga u zračenju/Heat output air	1.45kW
Minimalna toplotna snaga/Reduced heat output	8.30 kW
Snaga u radiatorima/Heat output water	7 kW
Snaga u zračenju/Heat output air	1.30 kW
Emisija CO/CO emission(at 13%O <sub>2</sub> )	Nominalna/Nominal 160 mg/Nm <sup>3</sup>
	Minimalna/Reduced 180 mg/Nm <sup>3</sup>
Stepen korisnosti/Efficiency	Nominalna/Nominal 93%
	Minimalna/Reduced 94%
Radni pritisak/Maximum water pressure	2.5 bar
Električni napon/ELECTRIC VOLTAGE	230 V
Frekvencija/FREQUENCY	50 Hz
Nominalna el. snaga/NOMINAL ELECTRICAL POWER	500 W

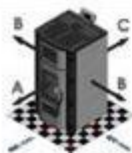

Minimalno rastojanje od zapaljivih materijala  
A=100cm,B=40cm,C=20cm/Minimal distance from combustible materials  
A=100cm,B=40cm,C=20cm

Gorivo/ FUEL C1  
Pridržavajte se uputstva/ Read and follow operating instructions  
Koristite samo preporučena goriva/ Use only recommended fuels  
U skladu sa standardom EN 14785:2006/ Complying with the norm EN 14785:2006

## 8.8 Proizvođa



RADIJATOR Inženjering D.O.O.  
Živojina Lazića Solunca br.6  
36000 Kraljevo, Srbija

## 9. Garancija

### 1. Radijator inženjering pokriva različite garancijske periode za različite delove (što je navedeno u daljem tekstu) samo ako su ispunjeni sledeći uslovi garancije:

- 1.1. Kamin mora biti priključen po navedenim hidrauličkim šemama iz tehničkog uputstva, naročito obratiti pažnju na montažu kamina na dimnjak i njegovo pozicioniranje. **(videti tačku 3.)**
- 1.2. Kamin mora biti priključen na dimnjak propisanog poprečnog preseka, karakteristika izolacije i visine. **(videti tačku 3.4)**
- 1.3. Dimovod od kamina do dimnjaka mora biti izveden po tehničkom uputstvu.
- 1.4. Kod kamina moraju biti izvršena i navedena elektro priključenja iz tehničkog uputstva, naročito se misli na karakteristike sobnog termostata, karakteristike mrežnog napona koji mora biti u određenim granicama.
- 1.5. Korisnik mora da se pridržava navedenih uputstava o korišćenju i održavanju. **(videti tačku 8.)**

### 2. Garancijska izjava

Izjavljujemo:

- da proizvod ima propisana i deklarirana kvalitetna svojstva.  
Obavezujemo se, da ćemo na zahtev kupca ako pravovremeno u garancijskom roku podnese zahtev za popravku, o svakom trošku izvršiti sve popravke kvarova, tako da će proizvod raditi u skladu sa deklariranim svojstvima,
- da će proizvod u garancijskom roku raditi besprekorno ako se budu poštovala uputstva za upotrebu, rad i montažu,
- da ćemo u garancijskom roku biti spremni da otklonimo sve kvarove na proizvodu i držati na zalihama sve potrebne rezervne delove,
- **garancijski rok počinje od DANA KUPOVINE I TRAJE 60 MESECI ILI 72 MESECA OD DATUMA PROIZVODNJE (datum proizvodnje nalazi se na nalepnici sa zadnje strane kotla),**
- **GARANCIJA OD 60 MESECI VAŽI SAMO AKO SE KOTAO REDOVNO SERVISIRA OD STRANE CENTRALNOG SERIVISA RADIJATOR INŽINJERINGA u periodu naznačenom za isti (dalje u tekstu),**
- **garancija važi ako je garantni list overen od strane prodavca i ako je upisan datum kupovine i priložen račun. TAKO JE BITNO JE IMATI I NALOG ZA PUŠTANJE U RAD. (overen od strane ovlašćenog servisa)**

**3. Garancijski period od jedne godine važi za sledeće delove:**

- za ležajeve,
- elektro grejača za potpalu.

**4. Garancijski period od dve godine važi za sledeće delove:**

- ventilator,
- automatiku kotla sa sigurnosnim termostatom i ostalim elektro delovima (presostat vode i presostat vazduha),
- sondu dimovodnih gasova,
- sondu temperature kotlovske vode,
- motor reduktor,
- pužne spirale,
- šolja za sagorevanje,
- elektro konektore,
- izolacijske materijale na vratima i otvorima za pušnice,
- turbulatore.

**5. Garancijski rok ne važi:**

- ukoliko se posle svake grejne sezone ne odradi redovan servis,
- za zamenu delova kod redovnog godišnjeg održavanja u skladu sa uputstvima,
- kod kvarova koje je na osnovu kupovine zbog nestručnog rukovanja proizvodom,
- kod mehaničkih kvarova nastalih prilikom transporta i prilikom korišćenja (vrsti predmeti),
- ako je proizvod instaliran nestručno, suprotno važećim propisima iz tog područja,
- ako je kupac koristio proizvod iznad deklariranih svojstava i u normalnim okolnostima,
- na staklo na vratima kamina;
- na ručicu za vrata kamina.

**6. Garancijski rok prestaje da važi:**

- ako se ustanovi da je kvarove otklanjala neovlašćena osoba ili neovlašćeni servis,
- ako kod popravke nisu bili upotrebljeni i ugrađeni originalni delovi,
- kad ističe garancijski rok.

**7. Kod prijave kvarova obavezno je dati sledeće podatke:**

- naziv i tip proizvoda,
- datum kupovine,
- fabrički ili radionički broj kamina,
- kratak opis kvara, odnosno nedostatka,
- tačnu adresu i kontakt telefon, mejl.

## 8. Redovan godišnji servis

Redovan servis se odrađuje na kraju svake grejne sezone u period od 15.4. do 31.8. i naplaćuje se utvrđenim cenovnikom firme “Radijator Inženjering”. Servisni postupak tehničkih lica koja obavljaju redovne godišnje servise, a koja su od strane proizvođača ovlašćena za to, obuhvataju sledeće operacije:

**! NAPOMENA: Serviser je dužan da pregleda sve navedene delove (sa liste) dozatora i izmenjivača, i ukoliko dođe do zamene bilo kojih delova na iste korisnik dobija gore navedenu garanciju kao i garanciju na još 12 meseci na telo kotla (izmenjivača). Garancija se može produžiti do 5 god. od datuma puštanja u rad. Servis i produženje servisa može da obavlja lice koje šalje centralni servis “Radijator inženjering”-a. Na nezamenjene delove posle odrađenog servisa garancija ne važi.**

- Demontaža pelet transportera, provera ispravnosti istog i provera ispravnosti ležaja i podmazivanje;
- Ležaj ne sme da ima otežano okretanje. U suprotnom ležaj se menja. Ukoliko se utvrdi da je do oštećenja ležaja došlo zbog upadanja vrstog predmeta u pelet transporter (zbog greške korisnika ili proizvođača peleta), Radijator inženjering naplaćuje vrednost ležaja.
- Demontaža šolje za sagorevanje od ložišta i išćenje prostora ložišta ispod šolje. Provera stanja šolje;
- Izvaditi sondu dimnih gasova i oistiti je od naslaga;
- Provera ventilator;
- Provera dihtovanja vrata;
- Provera održavanja kotlovskog izmenjivača.
- Išćenje dimovodnih kanala.

## Contents:

1. Important warning;
  - 1.1 Minimum distance from flammable materials;
2. Description of the **BIOlux 14** Boiler Heating Stove;
3. Assembly;
  - 3.1 General warnings;
  - 3.2 Measures and safety devices for **BIOlux 14** Boiler Heating Stove;
  - 3.3 Working space and positioning **BIOlux 14** Boiler Heating Stove;
  - 3.4 Installation of **BIOlux 14** Boiler Heating Stove onto chimney;
4. Cross-section of **BIOlux 14** Boiler Heating Stove with description of boiler heating stove elements;
5. Schematic connection of automation;
6. Table of technical data;
7. Hydraulic scheme;
8. **BIOlux 14** Boiler Heating Stove operation and maintenance;
  - 8.1 Control panel;
  - 8.2 Short manual for automatic control;
  - 8.3 Start of work of **BIOlux 14** Boiler Heating Stove;
  - 8.4 Mistakes during ignition and start of **BIOlux 14** Boiler Heating Stove;
  - 8.5 Maintenance of **BIOlux 14** Boiler Heating Stove;
  - 8.6 Nameplate;
  - 8.7 Sticker;
  - 8.8 Manufactured;
10. Warranty.



# 1. Important warnings

## GENERAL WARNINGS

- After the removing of the package check for the completeness of the delivery, in the case of defects, please contact the dealer who sold the boiler.
- The boiler must be used solely for the purpose envisaged by the manufacturer. Any liability of the manufacturer is excluded for damages to persons, animals or things, in case of errors during installation, regulation, maintenance or improper use.
- In case of leakage of water the device should be switched from the mains supply, close the water supply and inform the authorized service and authorized installers.
- This manual is an integral part of the device and must be kept with care and must always follow the device even in case of change of owner or user, or in case of connection to another installation. In case of damage or failure look for a new copy of an authorized dealer.

Pellet Boiler Heating Stove is a heat generator composed of the mechanical part where the water is under pressure, but also a lot of electrical components that are under voltage. In these devices where the possibility of contact of water and electrical components is high, it is necessary to observe the following general and specific safety measures:

- The use of the pellet boiler heating stove by the children and people with limited capabilities without accompaniment is not allowed.
- It is forbidden to use pellet boiler heating stove installations operating at temperatures higher than **110 ° C**, and pressure greater than **2.5 bar**.
- This device is a generator of thermal energy both through water and directly, by the emissions into the surrounding space. For that reason there are areas that are so heated that by contacting severe injuries may result. When working with those surfaces use protective means. Specially ensure that children do not come in direct contact with the device.
- It is prohibited to any person or technical intervention or cleaning the boiler before it is switched off the main power supply switch, the setting on the device (0) "off".
- It is prohibited to change the safety elements. Replacing these parts due to defects should be done with the approval of an authorized service representative of the manufacturer, ie. Co. Radijator Engineering or contact the manufacturer directly.
- It is forbidden to exposure boiler stove to atmospheric troubles. This device is not intended for outdoor use.
- No exposure to atmospheric turbulents. The boiler is not designed for outdoor use and contains no anti-freeze system.
- It is forbidden to put fingers or other objects through the openings in the outer parts of the shell of the unit. Inside the shell there are electrical components and wires under voltage

and devices that are mechanically driven (engine gearbox and fan). Contact with them may result in electric shock and mechanical injuries.

- It is prohibited to install the device in the vicinity of flammable materials; especially pay attention to the material that insulates the Boiler stove from the floor. It must be fireproof and proper dimensions. See Section "**Assembly**".
- Pellet Boiler Heating Stove must not be covered, nor on it or close to it can other objects be placed.
- For the operation of the pellet Boiler heating Stove it is necessary to bring in fresh air (see the Section "Installation"). The room where the Boiler heating Stove is situated should be aired several times during the day.
- It is forbidden to let a simultaneous forced ventilation (eg. kitchen air outlet fan ) and the pellet Boiler heating Stove in the same room. This can lead to poor performance of the unit, and also to the leakage of carbon monoxide, which can cause a man's choking.

### 1.1 Minimum distance from flammable materials

- Provide adequate distance from flammable materials, if necessary to ensure the protection of the same.
- Minimum distance from flammable materials is required by law - please inquire of professionals who deal with heating and Emission effluents.
- The minimum distance of the boiler and flue pipe gas from the low and averagely combustible materials should be at least 100mm.
- Minimum distance from flammable materials is 200mm, and the same goes for materials whose flammability is not known.



#### **Risk of fire!**

- Storage of flammable materials and liquids in the vicinity of the boiler is prohibited.
- Be sure to warn users about the required minimum distance of combustible material from the boiler.

<b>Combustibility of Construction materials</b>	
A ... Noncombustible	asbestos, stone, building stone, ceramic wall tiles, terracotta, plaster, screed (without organic additives )
B... Non easily flammable	Gypsum cardboard slab, glass fiber slab of ACUMINE, ISOMINE, ROYALITE, LIGNOS, VELOX, HERACLITE
C1.. <b>Low combustible</b>	beech and oak wood, composite wood, file, slab of HOBREX, Versalite, umakart
C2 ... Averagely combustible	wood of pine, yew and pine, composite materials
C3... <b>Easily combustible</b>	Asphalt, paperboard, cellulose materials, chipboard, cork, polyurethane, polystyrene, polypropylene, polyethylene fiber floor

## 2. Description of *BIOlux* 14 Boiler Heating Stove

*BIOlux* 14 Boiler Heating Stove is designed for space heating in two-fold manner, ie. By means of heating water for radiator heating within the Boiler Stove space and for heating of the surrounding area by emitting heat through glass and heated surfaces, above all gas channels that are positioned below the Boiler portion.

The energy that can be transferred into water at the emissions of gasses subject to the standard is **10,45 kW** and the emissions into the environment is **1,45 kW**.

Boiler Heating Stove consists of three assemblies whose basic components required to be supplied in the standard version:

- Boiler Stove portion together with the turbulence devices, the floor portion with the flue gas outlets and the outer casing with doors contain glass-ceramic component.
- Display, automation panel, motor reducer of pellet conveyor, sensor for water in the heat exchanger, flue gas temperature sensor, temperature sensor for space in which the Boiler Stove and other electrical equipment are situated.

Components of hydro installations which are mounted on the Boiler Heating Stove: circulating pump, expansion vessel of 10 liters capacity, the pressure safety valve, air vent cock.

Wood pellets are produced from 100 % cellulose. Wood residues under high pressure are compressed into pellets of 6 mm in diameter and in length of 2- 3cm. Pellets should be stored correctly in a dry place to ensure efficient combustion. Boiler stoves use pellet of 6mm diameter, of 5 -30mm length and humidity up to 10 % manufactured in accordance with **EN 14962-2**.

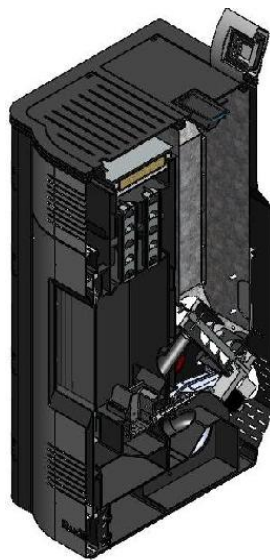

*Figure 1. Cross-section of *BIOlux* Boiler Heating Stove*

## 3. Assembly

### 3.1 General warnings

The *BIOlux* 14 Boiler Heating Stove must be set correctly for proper operation!



Maximum operating pressure of *BIOlux* 14 Boiler Heating Stove is 2,5 bar, 1 bar the minimum and maximum operating temperature of the boiler is 110 °C.



The firebox should always be closed when the appliance is in the operation.



*BIOlux* 14 Boiler Heating Stove together with a fan and automation system and both devices, use the power supply of 230V, so that improper installation and careless handling can endanger human lives by electric shock.



During installation follow the legal norms and regulations foreseen by the installation of the Boiler Heating Unit with wood pellets with hot water generator, which are valid in the country where the unit is installed, otherwise the Co. Radijator Engineering as the manufacturer takes no responsibility for the consequences of such installation.



If a change in the design, especially with the safety devices, lead to unintended consequences that can harm human health and life, Co. Radijator Engineering takes no responsibility.



The Unit must operate with fully correct and all safety devices that are listed and described in the following text. Glass ceramics on the door and all the flue channels must be without damages. Safety devices are to be serviced only with consultation with the authorized persons of the manufacturer or by contacting the manufacturer directly. Otherwise C. Radijator Engineering, as the manufacturer, can not overtake the responsibility for unintended consequences.



The manufacturer (Radijator inženjering) does not take any responsibility coming from the incorrect installation of the boiler.



No other fuels then pellets should be used.



For the installation of the appliance its mass should be taken into account.

*\*All national and local regulations and European standards should be complied with when installing appliance.*

### 3.2 Measures and safety devices for *BIOlux 14* Boiler Heating Stove

For safe operation of *BIOlux 14* Boiler Heating Stove it is necessary to assemble and maintain the following elements in working condition:

- **Pressure safety valve, air vent and gauge vent;**
- **Electro mechanical pressure switch for water;**
- **Pressure switch for flue gases;**
- **Thermostats in the automation of the boiler.**

**Pressure safety valve (figure 2), air vent (figure 3) and gauge vent (figure 4):**



*Figure 2. Pressure safety valve*



*Figure 3. Air vent*



*Figure 4. Gauge vent*

- Pressure safety valve factory is mounted and must be of nominal diameter of 1/2 inch calibrated to a maximum of 3 bars.  
This security element which belongs to the group of pressure limiters must be of such construction to withstand short-term overdrafts and temperatures and pressure as well as the content in the liquid glycol for heating.  
This safety element must be subjected to periodic re-calibration, of which the investor, i.e. the user of the boiler must have valid documentation.
- Recommend and install a pressure gauge (**Figure 4**) the hydraulic installation.
- Safety valve must be mounted on the highest point directly to the boiler and the boiler without any pipeline or any other elements in between. For this purpose there is a specially designed connector (see picture). Any reduction in the diameter of the connector during servicing and assembly of a new safety valve is strictly forbidden.
- Drain or exhaust of the safety valves must be of pipes with a diameter at least equal to the nominal diameter of the outlet part of the valve. You are allowed to use up its production of an arc of radius  $r > 3d$ .
- The safety valve must have a nameplate and the following information on it:
  - Name of manufacture;
  - Designation of type of safety valve / year of testing;
  - Nominal flow rate;
  - Data for which thermal effect the safety valve is set;
  - The highest opening pressure 3 bars.

- It is obligatory to check the correct functioning at regular intervals as well as the re-calibration by certified companies. These responsibilities are carried out in accordance with the law of every country in which the boiler is assembled. Always keep the written documentation of the last calibration data for the safety valve.
- On the return line assemble at least another pressure safety valve.
- Along with the pressure safety valve, the same security group includes vent valve. On this unit there are two such valves. One is on the highest point of the boiler and the other at the highest point of the collector at the point of branching pipe hot water and expansion vessel.

#### **Electro mechanical pressure switch for water (figure 5):**



*Figure 5. Electro mechanical pressure switch for water*

- This security element continuously measures the pressure in the boiler heat exchanger of the pellet Boiler Heating Stove and that information is transmitted to automation system. If the pressure is above or below the value of 0.5 to 2.7 bar then it leads to shutting down of the whole unit. Limit values of the minimum and maximum pressure values are determined by the operation program of automation.

#### **Pressure switch for flue gases (figure 6):**



*Figure 6. Pressure switch for flue gases*



- The purpose of this safety section is to continuously measure the underpressure of the flue gases in the flue channel area where it is connected, and to transmit this information to the automation system. If the value of the underpressure is above or below the value that is predefined in automation, there is the termination in operation of the entire unit on the automation display there is a warning that a mistake occurred in the operation.



**WARNING:** The disturbances in under pressure of flue gases can occur due to clogging of the chimney, a large dirt of flue channels in the pellet Boiler heating Stove, poor sealing of doors or glass-ceramic, the lids of the openings for flue channels etc.

- These conditions may lead to poor drainage of the combustion products, especially of carbon monoxide, which can, in extreme cases, lead to serious health problems and even choking of users.

### Thermostats in the automation of the boiler (figure 7):

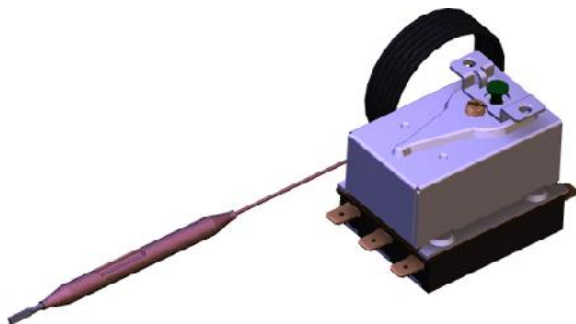

*Figure 7. Thermostats in the automation of the boiler*

Within the automation itself that leads the combustion process and influences the work of two cycles of heating, there are two thermostats. Both are of similar construction as the thermostat shown in **figure 7** and they have safety functions as limiters of the temperature of water in the boiler. Because of the safety role in the functioning of the boiler, both thermostats have the independent probes for measuring of water temperature.

The first thermostat is the so-called „working thermostat” work and it serves to limit the temperature to a level the user wants. Another thermostat is the „safety thermostat” because it stops the operation of the fan which favors the flame, and adds a new energy. Safety temperature is limited to 95 degrees Celsius.



**It is very important to connect the pump for heating through automation for safety reasons. When the temperature of water in the boiler reaches the critical value of 95 degrees the fan stops working, but the pump is necessarily switched on to exchange the heat of water through radiators.**





**The tap for filling and emptying should be installed at the lowest point of the system. Since there is no connection for filling and emptying on the stove itself, the tap should be connected to the lowest point of the return line. The installation should be filled slowly so as to remove air from the system. After the filling is complete, check for leaks on the central heating system.**

### 3.3 Working space and positioning of *BIOlux* Boiler heating Stove

When determining where to place the Boiler Heating Stove pay attention to the following details:

- Boiler Heating Stove must be as close to the chimney as possible, also supply of fresh air for combustion should be close.
- If possible, Boiler Heating Stove should be in the largest central room of the apartment/house which is heated because of better heat radiation effect.
- The unit must never be installed in a bedroom or a room that is impossible to separate from bedroom by the door
- The room in which pellet Boiler Heating Stove is installed another heating unit can not be used, such as a stove or a fireplace, solid fuel and pellet heating units. Necessary circulation of air through one of these devices is likely to be oppressed by the air supply to the other unit.
- The room in which the Boiler Heating Stove is positioned must be able to let the ventilation and connectivity with fresh air or with a room that is connected to external fresh air. This connection is made with non-combustible steel pipes.
- For the operation of the unit the power supply of 230 V and 50 Hz is needed. Place the pellet Heating boiler Stove as close to the connection socket as possible and on this occasion avoid extension cords.
- In case of setting the Boiler heating Stove on the combustible surfaces (floors, laminates, rugs, carpets, etc.). It is necessary to insulate the unit from such substrates with a plate of uncombustible materials (steel, ceramics, insulation materials, ceramic fiber, etc.). Such plates should be sized as to be larger from the base of the heating Boiler Stove (see **Figure 8**).
- Boiler Heating Stove must be at a safe distance from flammable materials such as wood and textile, pieces of furniture, curtains, plastic parts etc. The distance must be at least one meter from such materials.
- **Distance of the pellet Boiler heating Stove from the solid immovable objects (walls, columns, etc.) (Figure 8) laterally must be at least 40 cm (Figure 8 measures B), at the back of 20 cm (Figure 8 measures C) and at the front of 100 cm (Fig. 8 A measures). This gap distances are necessary because of approaching to hole for cleaning as well as for access during service interventions.**

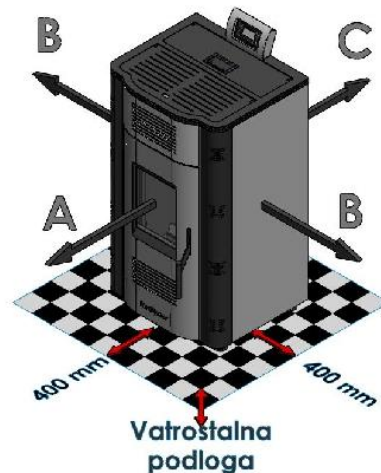

Figure 8. Display of Distance of Pellet Boiler heating Stove from fixed objects

### 3.4 Assembly of *BIOlux* 14 Pellet Boiler heating Stove onto Chimney

When connecting pellet Boiler heating Stove onto chimney there are two stages in assembly, as follows:

- **Installation of flue channels and intake of fresh air for combustion.**
- **Connection onto the chimney.**

#### **Installation of flue gas channels (Fig. 9) and fresh air inlet for combustion (Figure 10):**

- To connect Pellet Boiler heating Stove onto chimney special flue pipes that are certified for this purpose must be used. Materials used for making of these pipes are of structural and stainless steel.
- Diameter of the flue pipe must be appropriate to the diameter of the flue outlet being 80mm. Reducing this diameter is not allowed.
- The flue outlet must not be used for multiple heating units simultaneously.
- When installing the flue line a maximum of two smoke bends of 90 degrees are allowed. Maximum length of horizontal sections of the flue line is 2m.
- If the flue line is near flammable materials or it passes through them (decorative layer of the wall) it is necessary to insulate it.
- Flue pipes and fittings designed to connect to the pellet Boiler heating Stove usually have a silicone O-rings in places of connection. This should be necessarily checked, and if there not pre-embedded used silicone or some other refractory sealings.
- The flue must be periodically dismantled as to check its contamination or there must be an inspection hole.
- If smoke does not go directly into the chimney, but vertically upward, it is necessary to incorporate condensing tee (T-piece).

- Combustion air must be brought from the outside (from the environment) and be used with a tube made in black or stainless steel. The smallest allowed diameter of the tube is 50 mm.
- If it is not possible to bring air directly from the outside environment then it must be possible to supply it from the area that is in direct contact with the environment. The connection of such space with the environment must be such that it can not be accidental as to shut off the air (by closing doors, windows, etc.).

### **Connection onto Chimney (Figure 9, 10)**

When installing the chimney we distinguish two situations:

- **Situation 1:** Pellet Boiler Heating Stove is connected onto a standard chimney (masonry or metal) that has a foundation and a full cross-section of the base plate to the top.
- **Situation 2:** Pellet Boiler Heating Stove is connected onto prefabricated metal chimney attached to the facade.

#### **Situation 1:**

- The chimney uses ceramic or metal pipes of circular cross-section of 130mm diameter. Flue pipe must be insulated.
- If the chimney, already exists and is of square cross-section, then the minimum dimension of the intersection is 130x130mm.
- It is not allowed to use a chimney for connecting multiple heating units.
- It is not allowed to use the air vents like a chimney.
- Top of the chimney to be protected with the chimney cap due for the impact of rain and winds. Distance of chimney to cap is 200mm.
- Chimney should come out above the roof according to the recommendations of the showed in image. (Figure 11)  
If some other objects are near the chimney, take this into account, and then increase the height of chimney.
- The chimney must have a connection to extract condensation and an inspection door. The door should always be sealed well during the operation.

#### **Situation 2:**

- In this situation flue pipe must go at least 1.5 meters vertically upwards in the very room where the pellet Boiler Heating Stove is placed, and then penetrate through the wall and be connected onto the chimney.
- Flue pipe must have a T piece for condensation at the outlet from the Boiler heating Stove and the possibility of dismantling for cleaning.

**WARNING:** Failure to follow the rules during the execution of flue and chimney can lead to malfunction of the pellet Boiler heating Stove and endangering to human health and even to endangering of their lives. The biggest danger is from the toxic gases which are the products combustion process. In these situations where no flue, chimney and combustion air have not been constructed the way it was proposed in the instructions, Co. Radijator Engineering can not take responsibility for unintended consequences.

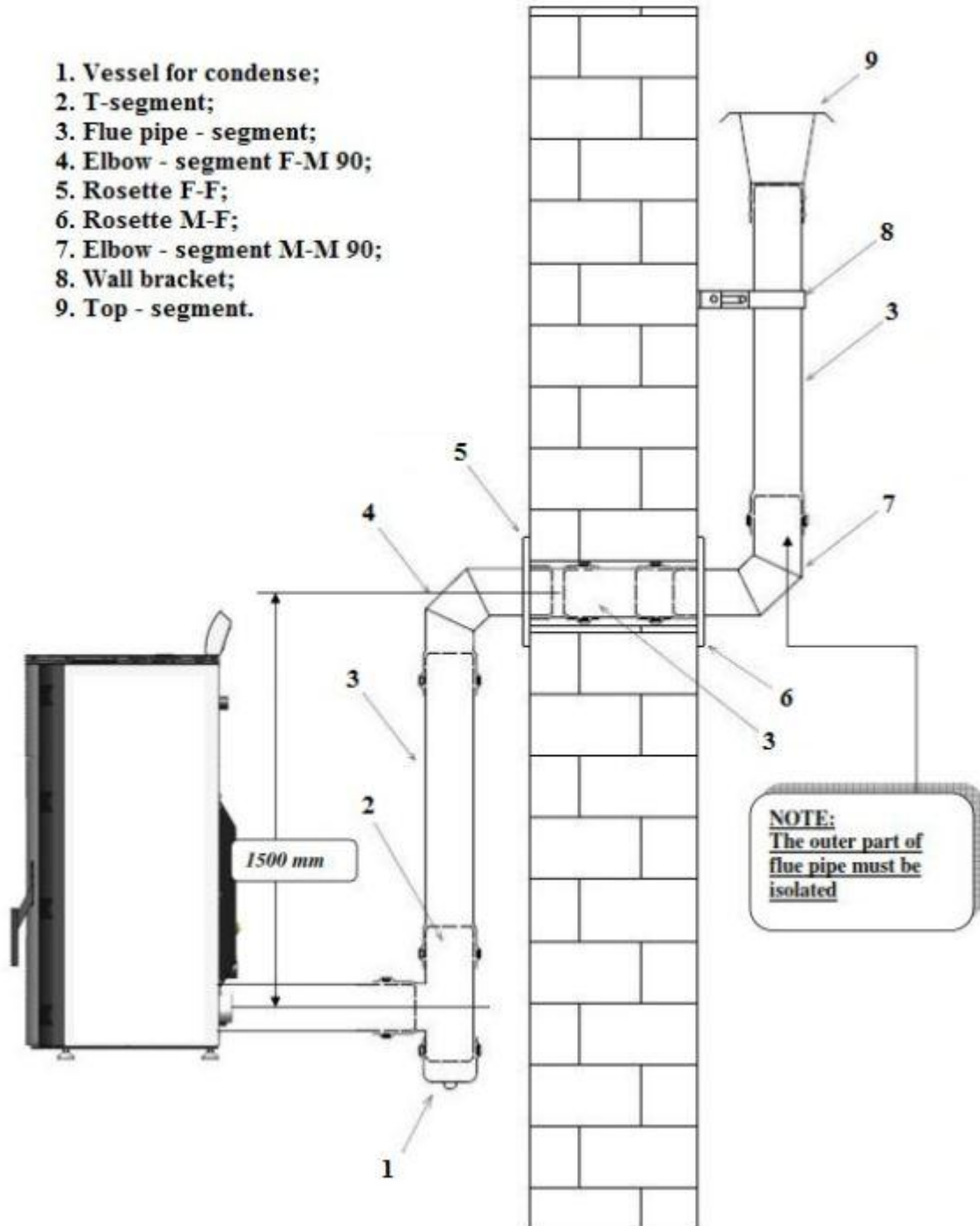

*Figure 9. Installation of flue gas channels*

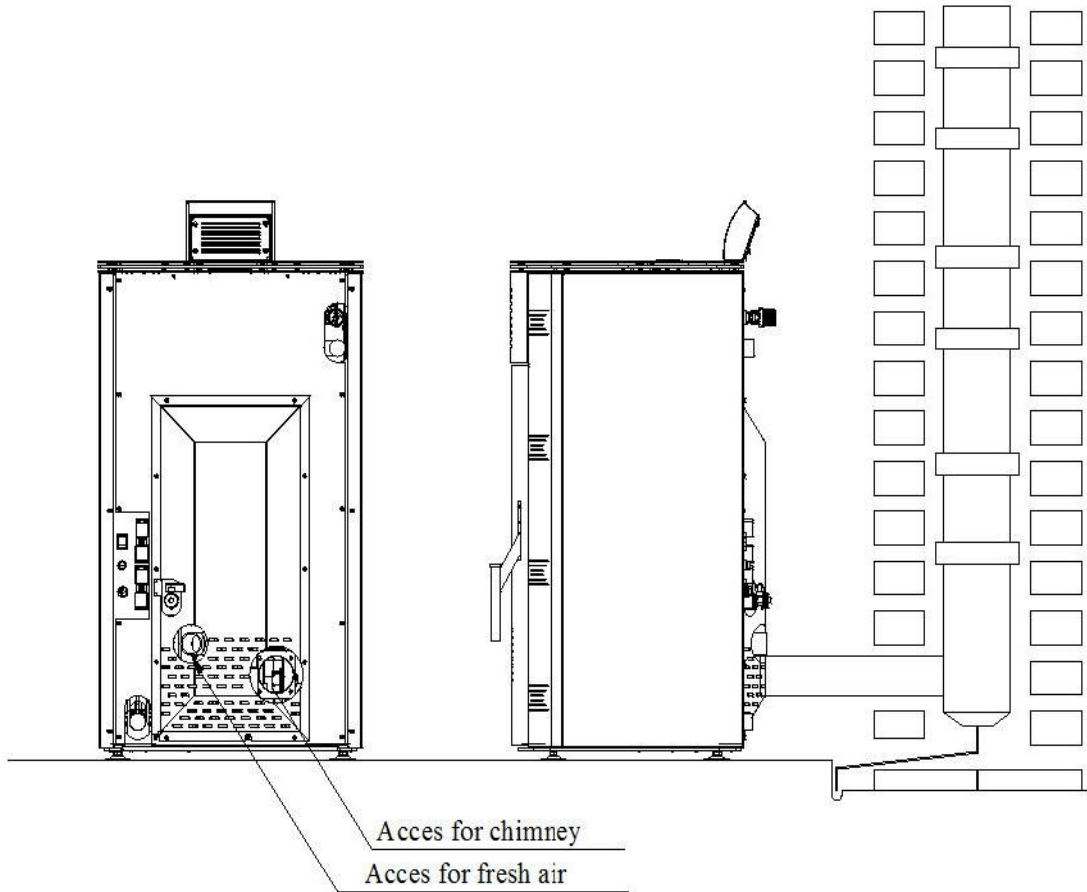

*Figure 10. Installation of flue gas channels and fresh air inlet for combustion*

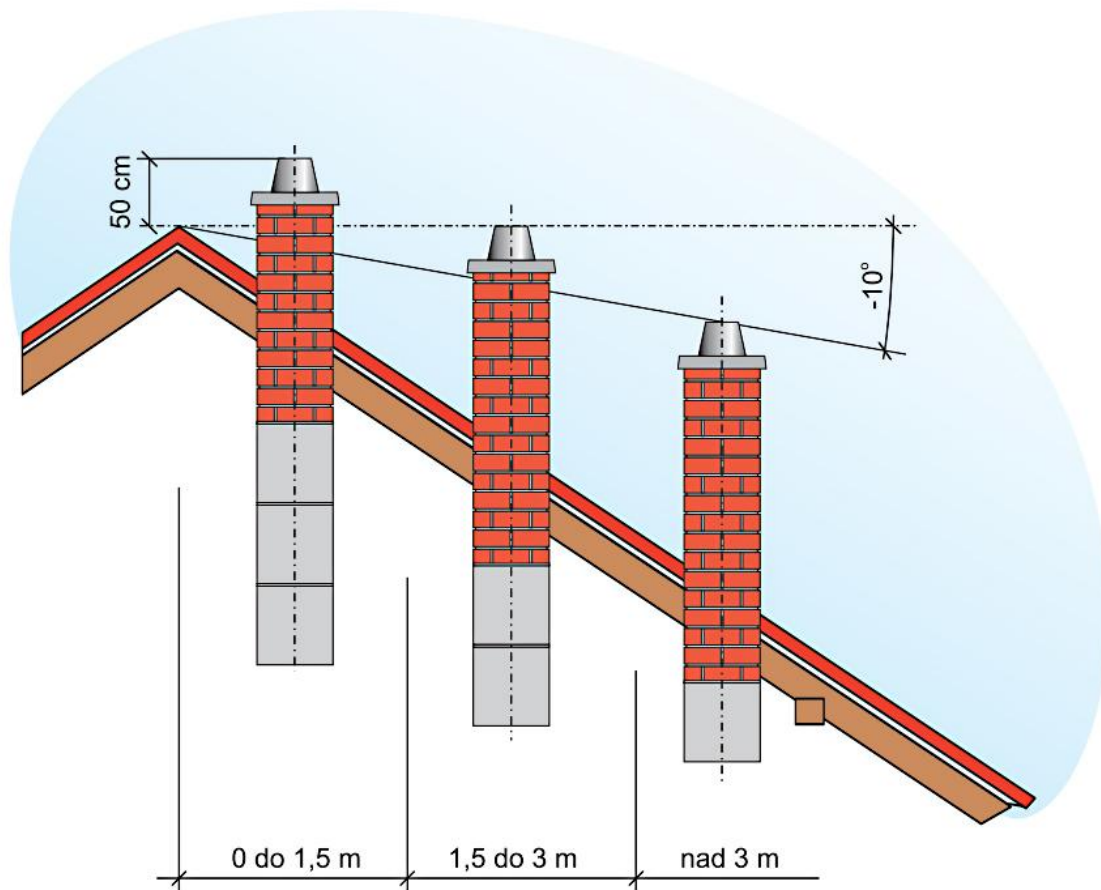

*Figure 11. Preview - recommended construction of the chimney.*



**To prevent risk of the fire in the chimney, user should clean the chimney at least once a year. In event of chimney fire user should stop the pellet stove and call a fire brigade.**



#### 4. Cross-section of *BIOlux* 14 Boiler Heating Stove with discription of boiler heatinh stove elements

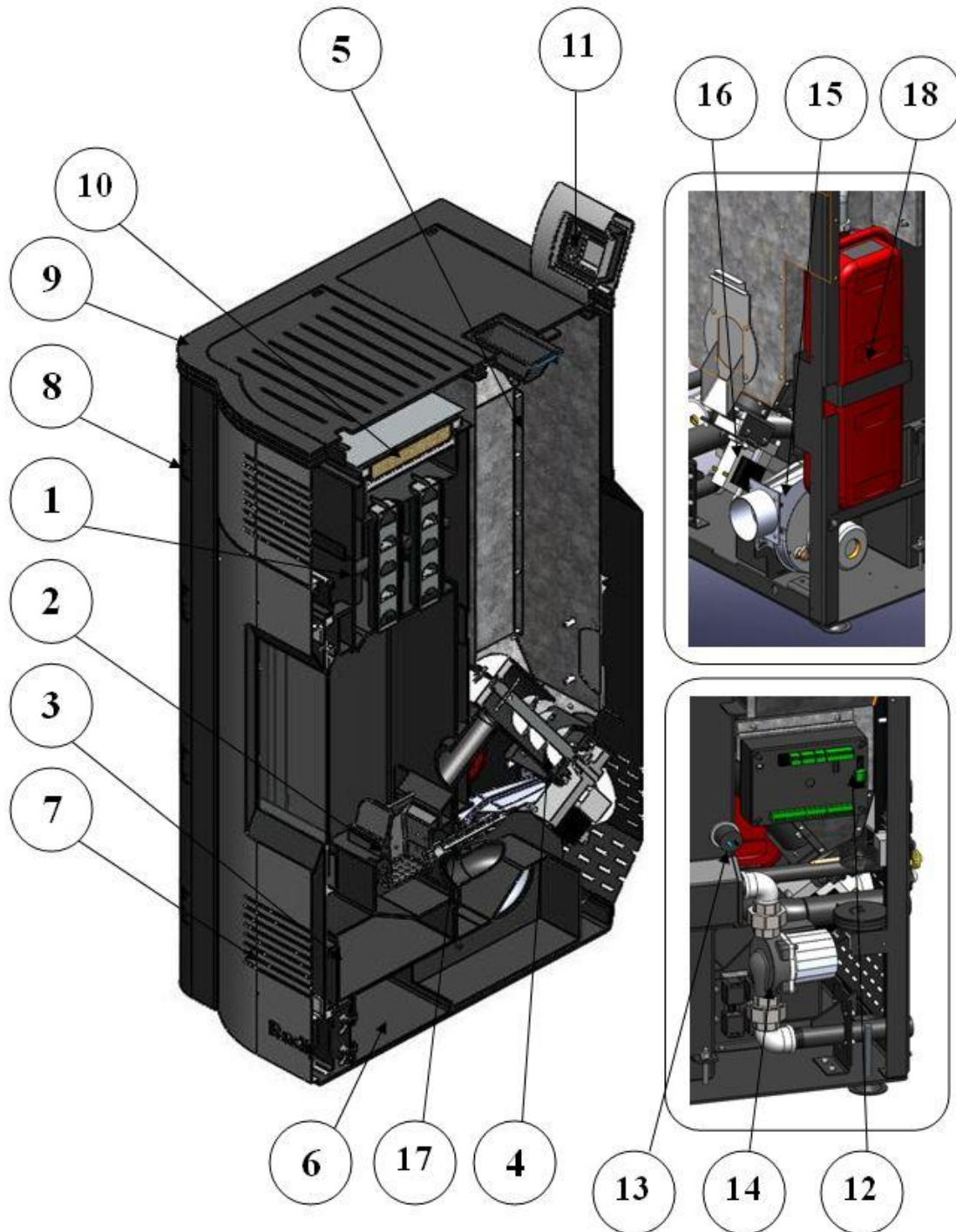

Figure 12. Cross-section of *BIOlux* 14 Boiler Heating Stove with discription of boiler heatinh stove elements

**Discription (figure 12):**

1. Exchanger with turbulators;
2. Combustion chamber;
3. Ashtray;
4. Feeding system;
5. Silos;
6. Flue (exhaust) duct;
7. Door;
8. Jacket of complete boiler heating stove;
9. Top of boiler heating stove;
10. Cover for cleaning on exchanger;
11. Automation;
12. Processor of automation;
13. Electro mechanical pressure switch for water;
14. Pump;
15. Exhaust fan;
16. Motor of feeding system;
17. Ignition;
18. Expansion vessel.

## 5. Schematic connection of automation

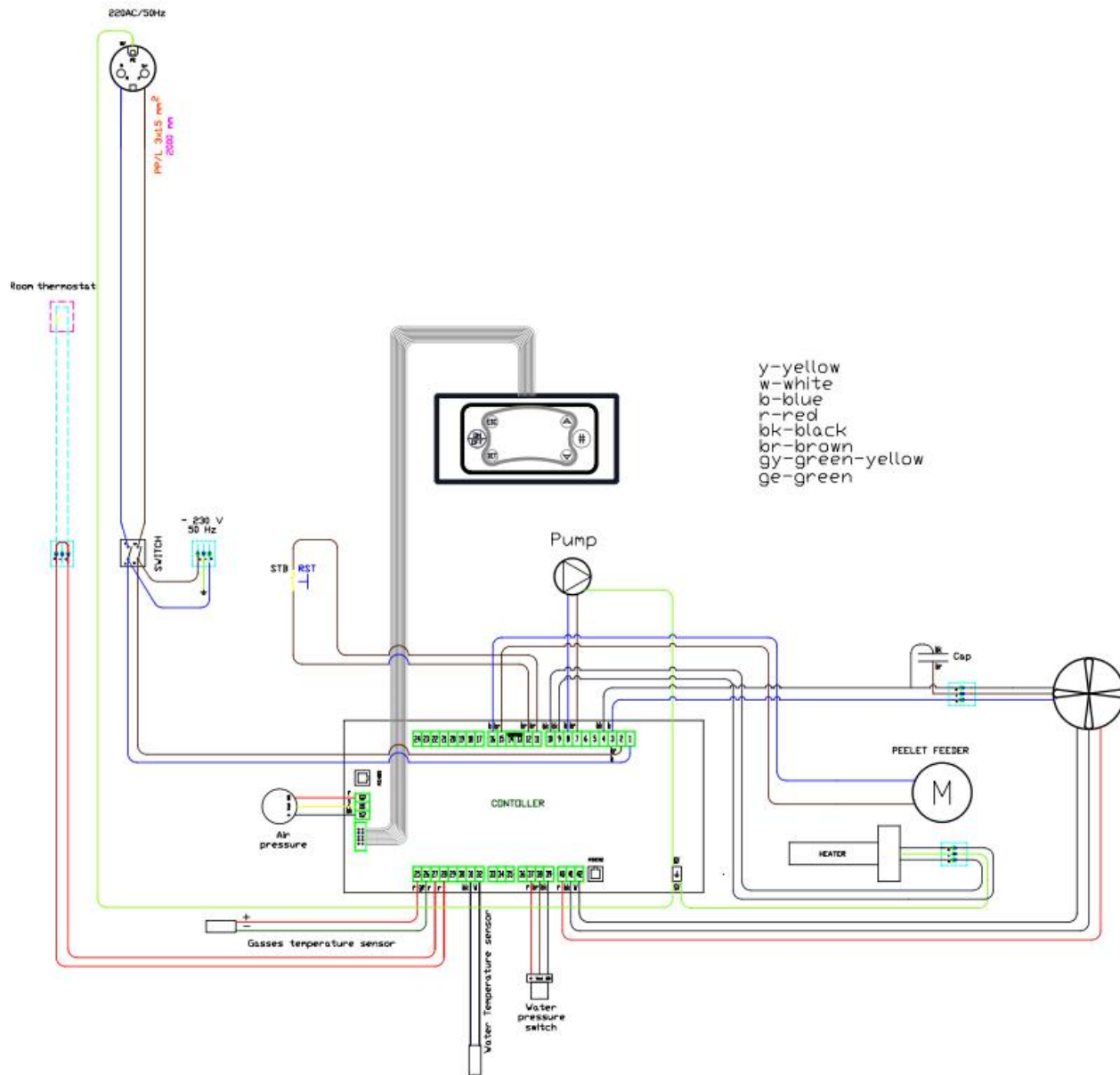

Figure 13. Schematic connection of automation

All lines that are displayed in the intermittent form in the diagram of external connections are the conductors which should be installed by the technician when connecting the external devices onto the automation system of the boiler. All the connections of the additional devices are performed by the technician through connectors located at the rear of the boiler.

One three-pole connector serves for the connection of the room thermostat as shown on the label the connector itself.



***For the room thermostats it is important to be battery-powered on, i.e. they should not have any supply of the voltage of 220 V. On the thermostat for the connection NC is used (normally closed contact).***

## 6. Table of technical data

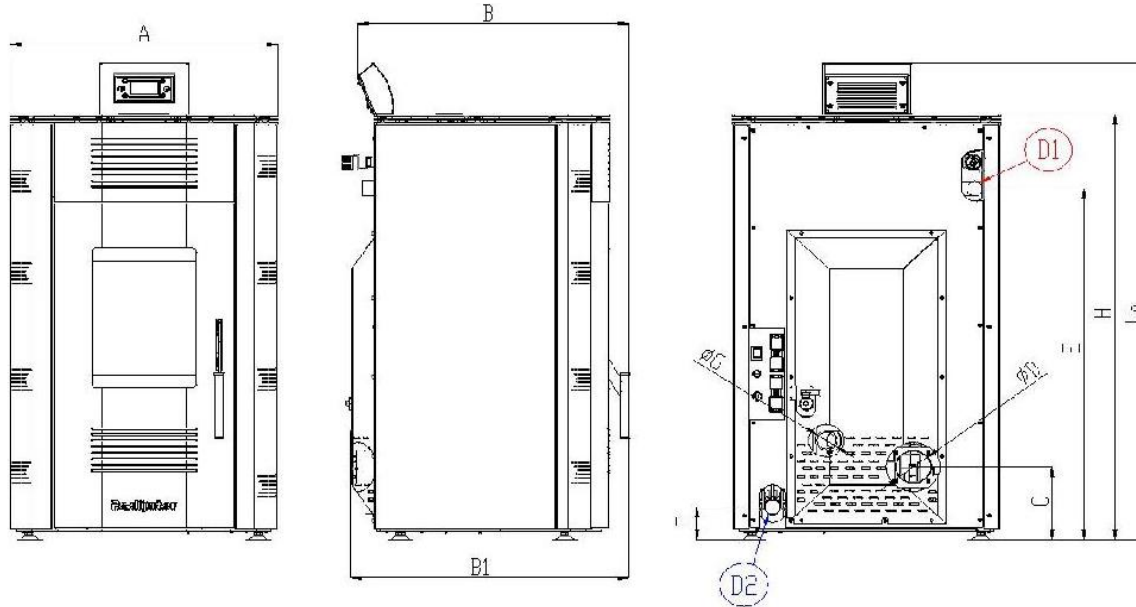

Type of boiler stove		<i>BIO Lux 14</i>		
	Units			
Nominal heat output	kW	11,90		
Heat output water		10,45		
Heat output air		1,45		
Reduced heat output		8,30		
Heat output water		7,00		
Heat output air		1,30		
CO emission at nominal heat output	mg/Nm <sup>3</sup>	160		
CO emission at reduced heat output		180		
Volume of water in the boiler stove	L-cca	24		
Mass of boiler stove	kg	192		
Necessary chimney draft	Pa	12±2		
Working pressure	bar	2,5		
Test pressure		5		
Max. temp. of hot water	°C	90		
Min. temp. of cold water		60		
Efficiency	%	>93		
DIMENSIONS	A	mm	600	
	B		606	
	B1		620	
	C		180	
	ØD		80	
	E		866	
	F		81	
	ØG		48.3 (6/4")	
	H		1050	
	Ha		1176	
	D1		col	1"
	D2			1"

### NOTE:

Access D1 – hot water  
Access D2 – cold water  
Access ØG – fresh air for combustion

\*The mean flue gas temperature directly downstream of the flue socket for nominal power is 135°C, and for reduced power is 90°C.

## 7. Hydraulic scheme

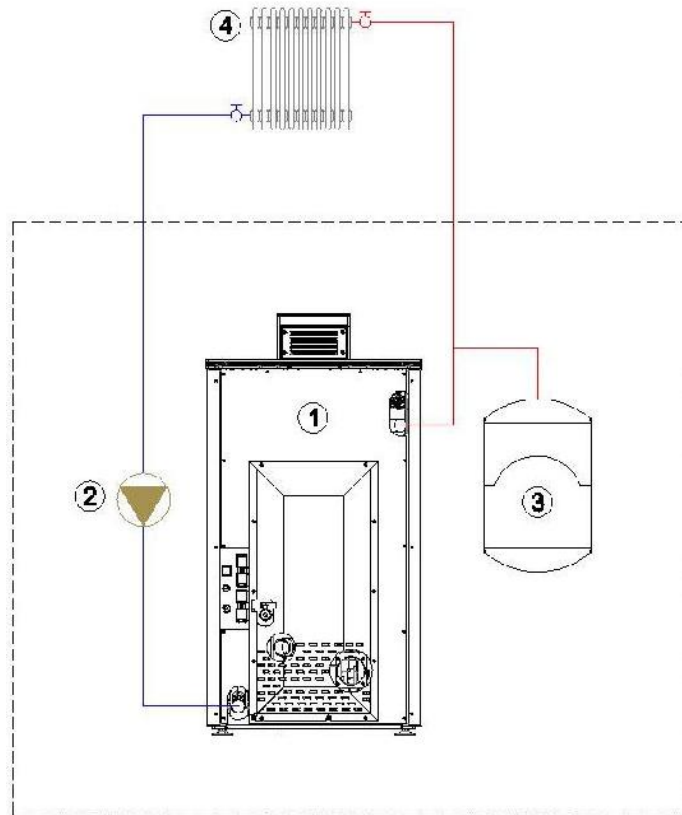



Figure 14. Hydraulic scheme

Description (figure 14):

1. PELLET stove;
2. Pump;
3. Expansion vessel;
4. Exchanger.

NOTE: In assembly of boiler heating stove includes pump and expansion vessel 10l.

 ***In an assembly the boiler should be properly protected against the excessive overpressure and overheating.***

 ***For the proper installation the plumber/installer is responsible.***

 ***The manufacturer (Radijator Inženjering) does not take any responsibility coming from the incorrect installation of the boiler.***

 **Note:** When filling the Hydraulic system pay attention to security elements shown in Figures 15.

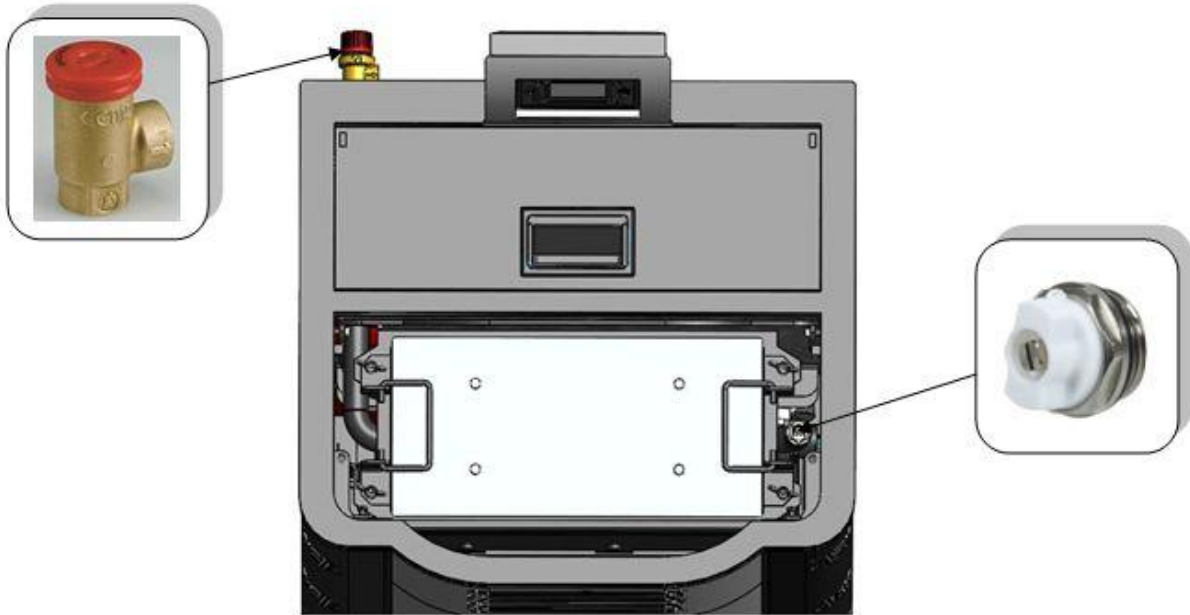

*Figure 15. Display of vent and safety valve on top of the pellet Boiler Heating Stove*



## 8. Start of boiler stove operation and cleaning



**First Commissioning of the boiler is performed by a Technician who has a Certificate issued by the “Radiator engineering” Co. Training of boiler users is mandatory.**

*In this way, the person is authorized to notify the customer service in the factory, time when the boiler started its operation in the condition of the boiler at its first firing, while a copy of the commissioning of the boiler in operation is retained. Guarantee and instruction manual are given to the customer. One copy of Guarantee is sent to the manufacturer.*

*If the guarantee is not filled in, it is not valid.*

*Only boilers that are operated only by authorized persons subject to technical conditions of complete guarantee of two years.*

*The following text is intended for the user of the boiler, as a kind of reminder, that if you turn off the boiler (eg for cleaning) will be able to independently run the boiler.*



*The parameters related to the operation of the boiler and which are available to the user on the display. Other parameters that are called hidden menu should not be changed without the approval of the technical person who has put the boiler into operation or the factory.*

### 8.1 Control panel

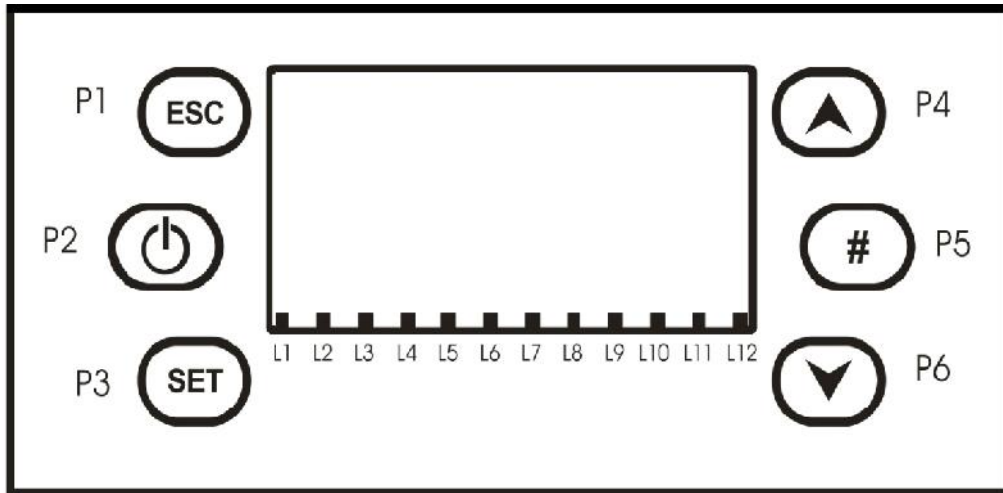

*Figure 16. Figure and diagram of Automation display*

**Buttons:**

Function	Description	Button
<b>On/Off</b>	Function Ignition, Extinguishing pushing the button for 3 seconds until the acoustic signal	<b>P2</b>
<b>Unblock</b>	Function unblocked when the system is in Block pushing the button for 3 seconds until the acoustic signal	
<b>Modify Menu and Submenu Values</b>	In modify mode change Menus and Submenus values	<b>P4</b> <b>P6</b>
<b>Run On Menu and Submenu</b>	In Menu run on Submenu and Menu	
<b>Visualizations</b>	Enter and run in Visualization Menu	
<b>Esc</b>	Function Exit managed pushing the button	<b>P1</b>
<b>Menu</b>	Function Enter in Menu or in a Submenu	<b>P3</b>
<b>Modify</b>	Enter in modify mode into a Menu	
<b>Set</b>	Save data in a Menu	
<b>Reset System Maintenance 2 Function</b>	Reset <b>T67</b> timer	<b>P5</b>

**Led:**

Function	Description	Led
<b>Heating Resistance</b>	Led On: Resistance ON	<b>L1</b>
<b>Auger</b>	Led On: Auger in the On interval	<b>L2</b>
<b>Pump</b>	Led On: Pump ON	<b>L3</b>
<b>Valve</b>	Led On: Valve ON	<b>L4</b>
<b>Output V2 configured as Pellet Safety Valve or Load Pellet Engine or Cleaning Pipe Engine</b>	Led On: Output V2 ON	<b>L5</b>
<b>Heating Fan</b>	Led On: Heating Fan ON	<b>L6</b>
<b>Output Aux2 configured as Pellet Safety Valve or Load Pellet Engine or Cleaning Pipe Engine</b>	Led On: Output Aux2 ON	<b>L7</b>
<b>Pellet Level</b>	Led On: lack of pellet	<b>L10</b>
<b>External Thermostat</b>	Led On: contact open	<b>L11</b>
<b>Flowswitch *</b>	Led On: Sanitary Water demand	<b>L12</b>

\* Only for plumbing with Flow Switch



**NOTE: Diodes L4, L5, L6, L7, L10 and L12 are not in operation in BIO<sub>lux</sub> 14 pellet boiler heating stove.**

## 8.2 Short manual for automatic control

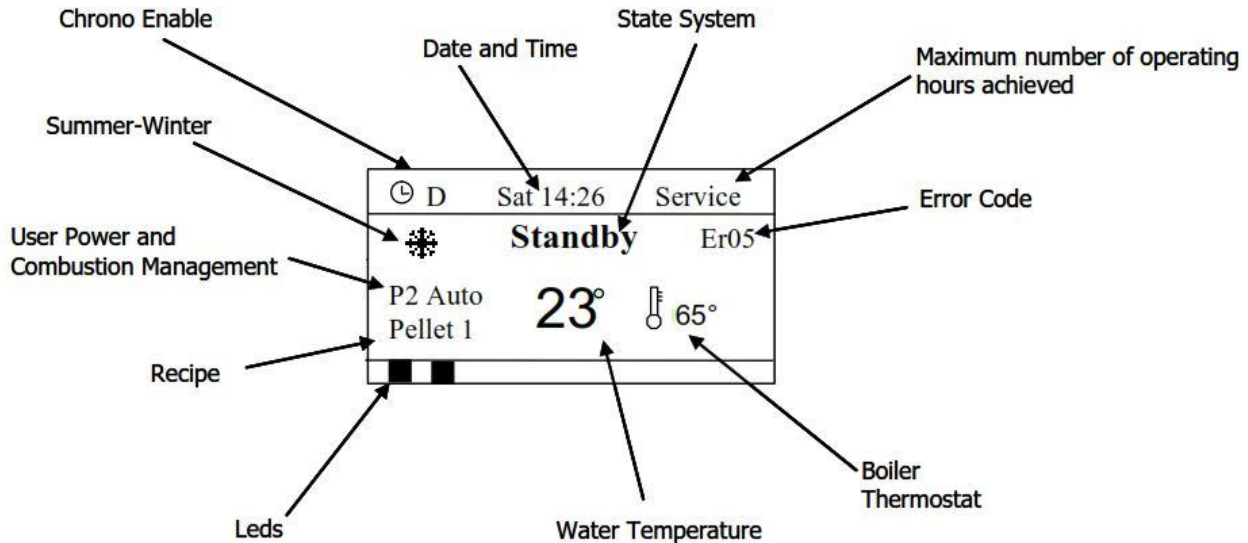



Figure 17. View of LCD screen on display

- **Reading of the current situation.**

Procedure:



Press the key **P6** , after that on the display the Information are shown (Figure 18).

<b>Exhaust Temp</b>	<b>103</b>
Boiler Temp	55
Buffer Temp	55
Room Temp	35
Pressure	1548
Air Flow	680
Auger	2.5
Product Code	395 – 0000
FSYSD01000101.0.0	
FSYSF01000131.0.0	

Exhaust Temperature [°C]  
 Boiler Temperature [°C]  
 Buffer Temperature \* [°C]  
 Room Temperature \*\* [°C]  
 Pressure [mbar]  
 Air Flow \*\*\*[cm/s]  
 Auger work time [s]  
 Product Code

Control Board Firmware Version  
 Keyboard Firmware Version

Figure 18. View of status display on pellet stove



**NOTE:**In the Pellet Boiler heating Stove BIO<sub>air</sub> 14 the information marked with an asterisk are not shown.



- **Enter the MENU of automation and an explanation of the function.**

Procedure:



Press the key **P3**, after that on the display there is the falling list (**Figure 19**).

MENU		DESCRIPTION
<b>Combustion Power</b>		Menu which allows to modify the combustion power.
<b>Heating Power</b>		Menu to modify the heating power. It is visible only if <b>P06=3</b> and <b>P44=6</b> .
<b>Boiler Thermostat</b>		Menu which allows to modify the Boiler Thermostat value.
<b>Buffer Thermostat</b>		Menu which allows to modify the Buffer Thermostat value. It appears only if <b>P26=2, 3, 4</b> .
<b>Room Thermostat</b>		Menu which allows to modify the Room Thermostat value (if a probe is used). It appears only if <b>A19=1</b> .
<b>Remote Keyboard</b>		Menu which allows to enable the Room Thermostat of the Remote Keyboard. It appears only if <b>A52&gt;0</b> .
<b>Chrono</b>	<b>Modality</b>	Menu to select the Chrono's program modality: Daily, Weekly, Week-End or disabled.
	<b>Program</b>	Menu which allows to program 3 period of time to switch on and switch off the system for each program modality.
<b>Recipe</b>		Menu to select the Combustion Recipes. It is visible only if <b>P04</b> is different to 1.
<b>Time and Date</b>		Menu to set time and date.
<b>Remote Control</b>		Menu to enable the Remote Control SYTX.
<b>Calibration</b>		Menu to modify the Auger's work time or the Combustion Fan speed.
<b>Load</b>		Menu to load the stove's brazier if the system is in Off State.
<b>Summer-Winter</b>		Menu to select the Winter or Summer modality.
<b>Language</b>		Menu to change the languages of the LCD panel.
<b>Keyboard Menu</b>		Menu to set the contrast and light of LCD panel.
<b>System Menu</b>		Menu to enter in the System Menu.

*Figure 19. View and explanation of the MENU of automation system*

- **Change the adjusted power of Pellet Boiler Heating Stove.**

Procedure:



Press the key **P3**, after that the falling list is shown on the screen, where the first

option is marked **Combustion Power**. Again push the key **P3**, after that there is

the view on display (**Figure 20**). With keys **P4** or **P6** you assign the

adjusted power and finally confirm again with key **P3**. Go back to the basic view

of the display (**Figure 17**), by pressing the key **P1**.

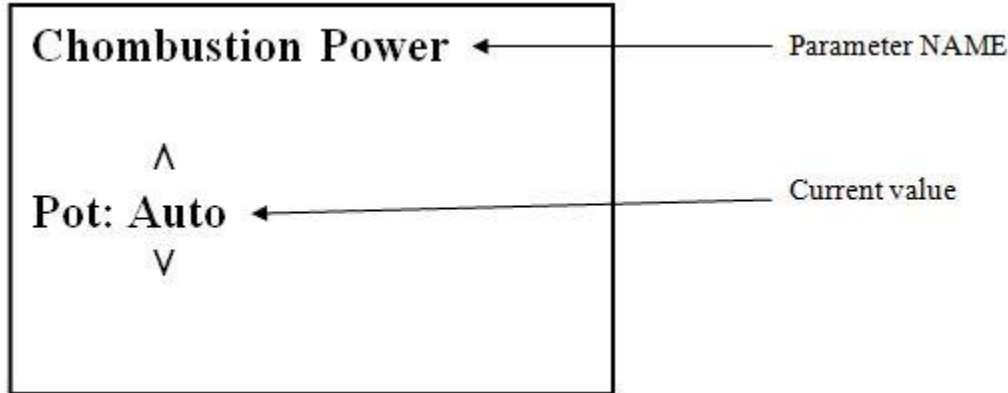









Figure 20. View and explanation of display in option Combustion Power



**NOTE:** In the Pellet Boiler Heating Stove **BIO<sub>lux</sub> 14** maximum adjusted power is 3. (Manufacturer's recommendation is to use **AUTO** mode of Power)



- **Change the assigned temperature of water in the pellet boiler heating stove**









Procedure:

Press the key **P3** , after that the falling list is shown on the display, where the first option is automatically marked **Combustion Power**. With Keys **P4** or **P6** , you come to the option **Boiler Thermostat**. Confirm again with key **P3** , (appears to view a similar view like on **figure 19**), then with keys **P4** or **P6**   assign the temperature and at the end confirm again with key **P3** . Go back to the basic view on the display (**Figure 17**), by pressing the key **P1** .

- **Change the precise time and date.**

Procedure:

Press the key **P3** , after that on the display there is the falling list, where the first option is automatically marked **Combustion Power**. With keys **P4** or **P6**  , you come to the option **Time and Date**.

Confirm again with key **P3**  and there is the view on the display Adjusting of time and precise date and through the keys **P4 or P6**   you pass from option to option through the key **P3**  you confirm the command and you change its value again through the keys **P4 or P6**  . When you choose the wished value it is confirmed with key **P3** . To enter or return for a step backwards use the key **P1** .

- **Set programming time for Ignition and Extinguishing of Boiler Stove.**  
**(USE THIS OPTION IF YOU HAVE PREVIOUSLY SET THE CORRECT TIME AND DATE)**





As for the time programming, in the option itself there are two sub-options such as: **Modality** and option **Program**.

**Modality** option serves to select the manner of programming, so, whether you will use the programming on a daily basis, every day separately (**Daily**) (Example: Monday, Tuesday, Wednesday ... Thursday), on a weekly basis (**Weekly**) (Monday to Saturday) , and on weekend basis (**week-end**) (Monday through Friday-and especially from Saturday to Sunday-special). You can totally switch off the option Chrono (**Disible**).







**Program** option serves for programming of the above options **Daily**, **Weekly** and **Week-End**, ie. adjusting the exact start time and break of operation of the Pellet Boiler heating Stove.

Procedure:

First, you should decide how you wish to program the start time and extinguishing, whether it be daily, weekly or weekend options. If you choose one of the quoted the selection will be done in the following way.

Press the key **P3** , after that the falling list is shown on the screen , where the first option is marked at once **Chombustion Power**. With keys **P4 or P6**  , you come to the option **Chrono**. Confirm again with key **P3**  (two options are shown



Modality and Program), then with keys **P4** or **P6**   you come to the wished option **Modality** and you confirm it with key **P3** . After that, in the sub-menu you come across to the option **Daily**, **Weekly**, **Week-end** and **Disable** (shown in Figure 21). With keys **P4** or **P6**   choose one of them and confirm with key **P3** .

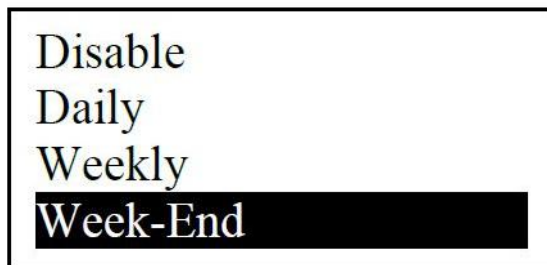









Figure 21. View of display after the selection of the option MODALITY

When you have chosen the manner of programming, automatically you return to the view on display **Modality** and **Program**. With keys **P4** or **P6**   you pass to the option **Program** and you confirm with key **P3** .

In this option, you program the correct time of ignition and extinguishing of Boiler Heating Stove that you previously selected in the option Modality. Examples of programming are shown in **Figures 22, 23 and 24**.

For further passing use the keys **P4** or **P6**  , for confirming the key **P3** , to confirm the selected values confirm with keys **P5** , and for one step backwards the key **P1** .

Daily	Monday	Monday
Weekly	Tuesday	ON OFF
Week-End	Wednesday	09:30 11:15 ✓
	Thursday	00:00 00:00
	Friday	00:00 00:00

Figure 22. View of display after selection of the option Daily

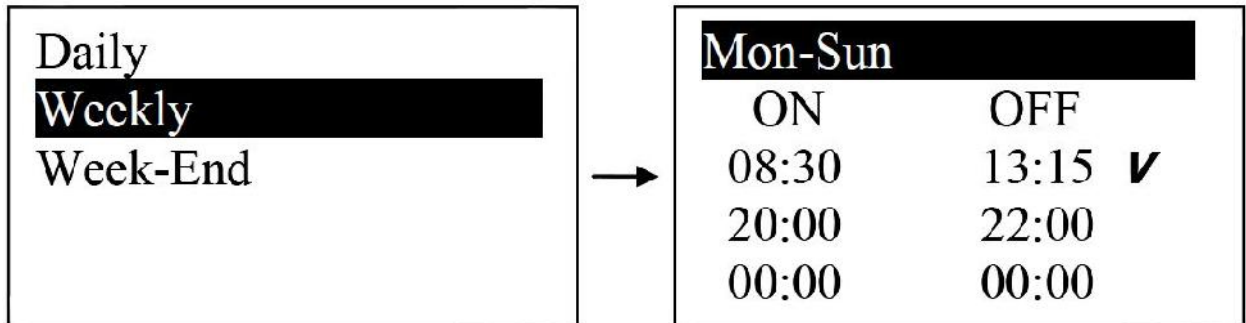

Figure 23. View of display after selection of the option Weekly



Figure 24. View of display after selection of the option Week-end

### 8.3 Start of work of *BIOlux* 14 boiler heating stove.

- **STEP 1:** Pellet boiler heating stove connected on hydraulic system.
- **STEP 2:** Infuse a small amount of pellets in the silos and close it.

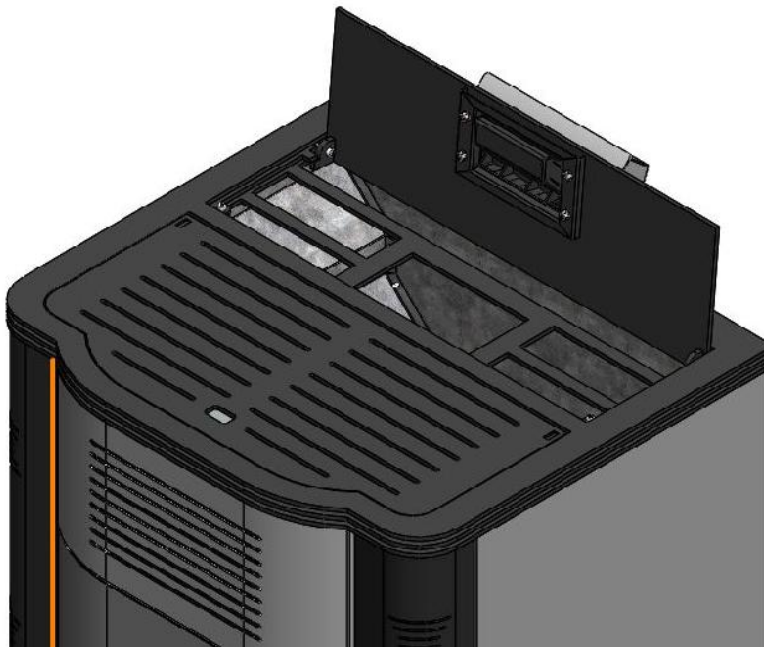

Open the lid of the sillo and infuse the small amout of pellets in the sillo and close it.

- **STEP 3:** Switch on the boiler heating stove, the switch is positioned on the rear portion of the boiler heating stove.

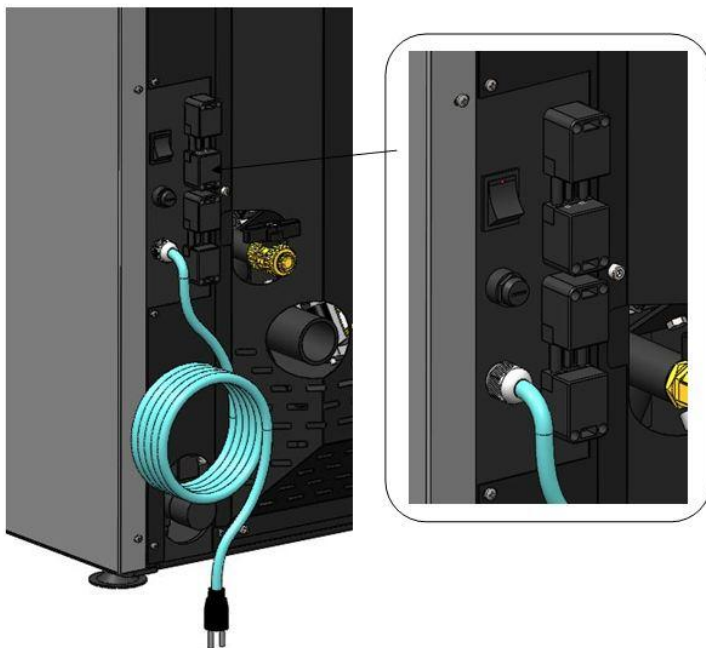













Figure 25. View of the position of the Plug and main switch and safety thermo-couple

- **STEP 4:** Initiate feeding system as the first grains of the pellet might fall into the combustion cup / space. (This procedure can be applied only when the Automation system is in OFF mode (Figure 17 : state of regime))

Procedure:

Press the key **P3** , then with keys **P4 or P6**   in sub-menu you come to the function **LOAD**, confirm with key **P3** , with keys **P4 or P6**   you pass from **OFF** to **ON**, confirm with key **P3** . By confirming with key the feeder is started, until the first grains of pellet start falling into combustion cup/space.

After that, also, with keys **P4 or P6**   you pass from **ON** to **OFF**, confirm with key **P3** . The feeder stops working. With key **P1**  exit the sub-menu.

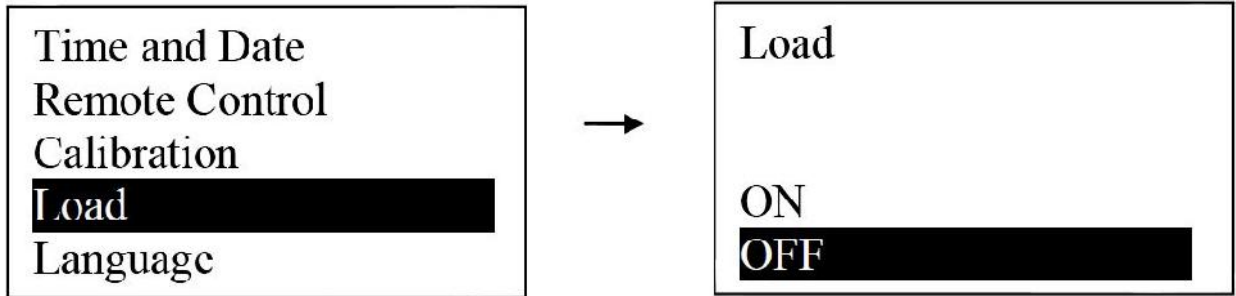

*Figure 26. View of display when selecting the function LOAD*

- **STEP 5:** Start up of Pellet Boiler Heating Stove.  
 Procedure:



Press the key **P2**, hold pressed for 2-3 seconds until the beep signal. Then on the display there is the text **IGNITION** (Figure 17-State of system). The Boiler Stove started working.

In the conditions when the pellet is according to the standards and when all other requirements are met for chimney and air flow, the combustion process begins in 5 to 10 min.

During the first firing some increased presence of smoke and the sharp smell should be expected until the factory coatings against corrosion end or until the final drying or stove being heated.

The same procedure is used for extinguishing the Boiler Stove, so by a prolonged



pressing of the key **P2** until the beep sound is heard, then on the display is the text **Extinguish**. (Figure 17-State of system ), we pass to extinguishing of the Boiler Stove.

- The room thermocouple (thermostat) can be connected to automation system. In this case, it is important to adjust the room temperature, which is the main parameter for the operation of the boiler stove and water temperature in boiler stove (70 °C). When the room thermostat is activated, the boiler stove has the first need to reach the room temperature, under the condition that it is limited by adjusted degree of water temperature in it. There is a possibility that the boiler stove stops working before the adjusted temperature of the room thermostat, in this case the set temperature of the water in the boiler stove should be raised, Example to: 70 °C.

**Warning: Be sure to make the analysis of the flue gases after the finish of installation of the boiler. Measure the percentage of oxygen (O2).**

## 8.4 Mistakes during ignition and start of *BIOlux* 14 Boiler Heating Stove.

All possible errors in the initial stage of operation, ie. during firing and can, even during the operation, are shown in the display of the automation system. (**Figure 16-** ALARM error).

Errors and explanations are shown in the table.

<b>Er01</b>	Error Safety High Voltage 1. Also with the system Off
<b>Er02</b>	Error Safety High Voltage 2. Only if the Combustion Fan is On.
<b>Er03</b>	Extinguishing for exhaust under temperature
<b>Er04</b>	Extinguishing for water over temperature
<b>Er05</b>	Extinguishing for exhaust over temperature
<b>Er07</b>	Encoder Error. This error can occurs for lack of Encoder signal
<b>Er08</b>	Encoder Error. This error can occurs in case of adjustment problems of rounds number
<b>Er09</b>	Water pressure low
<b>Er10</b>	Water pressure high
<b>Er11</b>	Real time clock error
<b>Er12</b>	Extinguishing for Ignition failed
<b>Er15</b>	Lack of voltage
<b>Er17</b>	Air Flow Regulator Error
<b>Er18</b>	Run out of pellet
<b>Er39</b>	Air Flow Regulator Sensor broken
<b>Er41</b>	Minimum air flow in Check Up not reached
<b>Er42</b>	Maximum air flow Up reached ( <b>F40</b> )

All possible problems and stoppage in the operation of this device can be divided into two major groups.

- **Group I.** Stoppage during the first firing and the first firing after purchase of the boiler or the first putting the boiler into operation during the day.
- **Group II.** The delay that occurs when the boiler has already been in operation process , the display is there is a notification on the display ( Run Mode) , but after reaching the set temperature and rest mode it loses the continuity of combustion .

### Group I

The most common indication on the display related to this type of error is Er12. During the first firing after the installation of the boiler, for the hydro installation there should follow the instructions from the Section "Start of Operation of the Heating Boiler-Stove." Especially, pay attention to the flue outlet (diameter, number of arcs, sealing, ... ) as well as to the chimney (diameter , height , insulation , sealing revision openings, dirt in chimney , etc.). If, after the first attempt of firing there is no significant occurrence of flame and serious increase in flue gas temperature, there is a signal on the display that the ignition heater is activated, and yet the boiler goes into extinction phase (Extinguishing). In this case you should check out the following causes:



#### Possible **cause 1.**

- **Problem 1.** Poor quality of pellets. Pellets are of low power, and increased humidity
- The procedure for troubleshooting of **Problem 1.** Provide the pellet of proved quality and test it.

#### Possible **cause 2.**

- **Problem 2.** Air temperature (which was brought to the fireplace for firing and burning) is extremely low (below zero ).
- The process of resolving the **Problem 2.** Prolonging the time for preheating of heaters for firing  $t_{02}$  to the range of 30 - 40 seconds.

#### Possible **cause 3.**

- **Problem 3.** Mains voltage that is connected onto the boiler is considerably lower than 220- 230V, so the power of the heater is lower.
- The process of resolving the **Problem 3.** Raising the time for preheating heater for firing,  $t_{02}$ , to the range of 30 - 40 seconds. If this measure does not work then connect the AC Voltage adapter.

#### Possible **cause 4.**

- **Problem 4.** The amount of pellets in the combustion chamber is insufficient to put the boiler into operation.
- The process of resolving the **Problem 4.** Possible mechanical problems with pellet conveyor. Check the accuracy of dozer.

#### Possible **cause 5.**

- **Problem 5.** There are situations in which there is a flame , but by checking the exhaust gases it can clearly be seen that there is not enough pellets for the boiler to pass from the stage of stabilization ( Stabilization) into operating mode ( Run mode). This occurs because the pellet structure (length, stickiness, the amount of dust, etc.) is such that the time  $t_{03}$  of fixed feeding is not sufficient.
- The process of resolving the **Problem 5.** This problem is eliminated by extending the time of fixed feeding,  $t_{03}$ . Recommendation is that this time is extended cautiously, first for ten or fifteen seconds, and if that is not enough then for another five seconds and so on. After that, resolving the troubleshooting should be combined with the procedure from the following item.



#### Possible **cause 6.**

- **Problem 6.** After the fixed phase of feeding (t03) there the flame occurs, but at this stage of t04, during this period it is not possible to pass into the stabilization (Stabilization) , and the flame is becoming weaker so there is a decrease of the temperature of flue gases and shutting down (extinguishing). This problem occurs because of the varying quality of pellets.
- The process of resolving the **Problem 6.** Reduce the time t04. It is recommended that you do it carefully. It is possible to combine this procedure with the solution contained in the previous item.

#### Possible **cause 7.**

- **Problem 6.** The boiler is connected to the room thermostat. By increasing the set temperature on the room thermostat the boiler does not enter the firing phase (Ignition) and there is not activation of the firing heater.
- The process of resolving the **Problem 7.** Check whether the temperature in the room is really lower than the set temperature. Also check time programming for the room thermostat and finally check the correct functioning of the room thermostat.

## Group II

The most common indication on the display related to this type of errors is **Er03**.

#### Possible **cause 1.**

- **Problem 1.** The Heating boiler-the Stove was fired and in was in the operating mode (Run mode), but it came to the stoppage; and when it stopped again and got the command from for work either from the boiler thermostat or room thermostat. The combustion chamber is, in such situations, full of unburned pellets.
- The process of resolving the **Problem 1.** Check the values of the parameters A26, Th28 and Th06. Maybe there was an accidental changing of their values. Parameter A26 needs to be 1 , the parameter Th06 between 60 and 65, while the parameter Th 28 in any case should for at least two degrees lower than Th06. In such cases parameters should be changed, empty chamber (burning bowl) and then restart the boiler.

### Possible **cause 2.**

- **Problem 2.** The Boiler Stove was ignited, and entered the operating mode (Run mode), but as time goes on there comes to an increasing accumulation of pellets at the bottom of the combustion chamber. As the time goes on the unburned pellet fills the combustion chamber and a reduction in the flame and the boiler is extinguished. (Extinguishing).
- The process of resolving the **Problem 1.** Increase the fan power. It is best to increase the fan power in all modes through the function of calibration (Calibration-exhaust fan).

### Possible **cause 3.**

- **Problem 2.** Heating boiler-Stove works, but in the course of work there comes to a stoppage and a sign is displayed-Modulation, and then to the Safety shutdown (Extinguishing). At the end the display indicates the error Er05.
- The process of resolving the **Problem 3.** This occurs because the flue gas temperature is too high. The most common causes are contamination of the boiler-Stove, the chimney is too strong, too strong fans in operating mode, excessive loading of pellets, pellet characteristics, and so on. The delay can be eliminated by adjusting some of the parameters or by increasing parameters for passing the boilers into modulation and safety shutdown, due to flue gases, which are parameters Th07, Th08.

## 8.5 Maintenance of *BIOlux* 14 Boiler Heating Stove.

*BIOlux* 14 pellet boiler heating stove requires daily and periodic cleaning.

- Daily cleaning also refers to the area of the combustion chamber ie. Combustion cup where by the constant ejection of ash allows a better working of electric heaters for firing and a better combustion ie. A bigger amount of air through the slits in the cup. Also, the ash, even in the course of a day begins to accumulate on the bottom, the space around the combustion space. Pri prose nim parametrima sagorevanja 100kg peleta proizvede 1kg pepela.
- In every 3 to 7 days it is necessary to clean the space of combustion chamber (**figure 27**). Also it is necessary to clean the deposits on the walls of the firebox. By this we provide a better transfer as one millimeter layer of tar and soot decreases the conductivity by 5%.
- Once in a month it is necessary to open the top cover for cleaning, turbulators and then from the whole area of the boiler the tar and soot should be removed (**figure 27**). All that is removed in this way, can be collected and taken away through lower openings. Also during that period the inspection holes of the flue channels should be opened, which also need to be cleaned from soot and tar deposits, as well as from the ashes.

If, during the cleaning in the boiler there appears the condensation it is necessary to collect the condensed matter and the whole boiler inside should be coated by base means for cleaning or else by means of water solution of construction lime. In this way the neutralization of acids is carried out due to condensation.

 ***While maintaining and servicing the boiler, the boiler is to be switched off the power supply.***

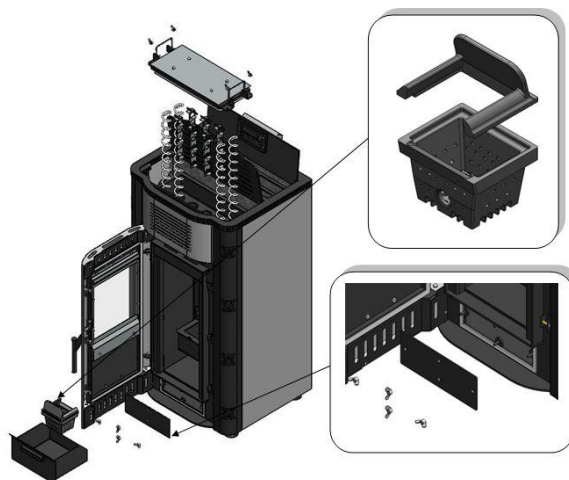

*Figure 27. View of elements that are dismantled during the cleaning*

 ***In this way the boiler is conserved at the end of the heating season. In this situation, close all openings of the boiler to prevent the circulation of air through the boiler as the moisture can occur in the boiler as well.***

 ***Maintenance of the boiler is one of the most essential factors for the length of working life of the boiler. It is particularly important that the boiler be cleaned when out of operation season and neutralization of acids be done as already described.***

## 8.6 Name plate.

The nameplate is stuck on a well visible place on the boiler and includes the following (see the image in the item: STICKERS):

### 1. Tehnical data on sticker:

- Manufacturer (Radijator Inženjering)
- Serial number of boiler (primer: N°:170616003)
- Year of product (primer: 2016)
- Type of boiler (**BIO<sub>air</sub> 14**)
- Nominal heat output (11,90kW)
- Heat output water (10,45kW)
- Heat output water (1,45kW)
- Reduced heat output (8,30kW)
- Heat output water (7,00kW)
- Heat output air (1,30kW)
- CO emission (Nominal - 160mg/Nm<sup>3</sup>, Reduced - 180mg/Nm<sup>3</sup>)
- Efficiency ( Nominal - 93%, Reduced - 94%)
- Maximum water pressure (2,5bar)
- Electric voltage (230V)
- Frequency (50Hz)
- Nominal electrical power (500W)
- Fuel (Pellet - C1)

### 2. Sticker of importer

### 3. OEEO

### 4. Other markings on the boiler



## 8.7 Sticker.

On *BIOlux* 14 pellet boiler heating stove there are stickers identifying the connections as well as labels against the risk of electric shock, stickers for scheme of connections etc.

### Labels that indicate connection to the installation:

1. Sticker (Hot water) 32mm x 74mm



2. Sticker (Cold water) 32mm x 74mm





### 3. Sticker (Hydraulic scheme) 148mm x 210mm

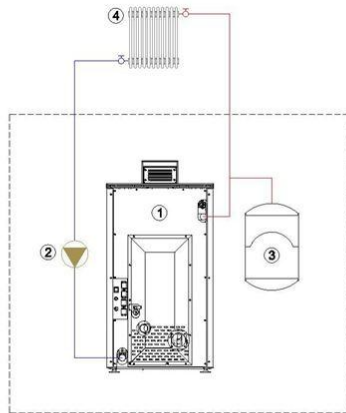

Slika 14. Sema povezivanja

Opis (slika 14):

1. PELET kamin;
2. Pumpa;
3. Ekspanzivna posuda;
4. Radijator (izmenjivač).

NAPOMENA: U sklopu PELET kamina ulazi i pumpa i ekspanzivna posuda od 10l.

### **Labels that indicate the presence of electricity high voltage and danger:**

#### 1. Sticker (Input with low voltage 12V) 60mm x 80mm



2. Sticker (Hayardous voltage - BIGGER) 100mm x 150mm



3. Sticker (Safety electrical connection) 20mm x 30mm



4. Sticker (Presence of voltage)



**Labels that indicate warning:**

1. Sticker (Exposed Exposed moving parts can cause severe injury) 30mm x 80mm



2. Sticker (Only an approved installer is authorized to start boiler)  
65mm x 247mm



3. Sticker (Warning)



4. Sticker (Waste)



**Labels with technical data:**





**BIOlux 14** N°170616003  
Godina/Year: 2016

Nominalna toplotna snaga/Nominal heat output	11.90 kW
Snaga u radiatorima/Heat output water	10.45 kW
Snaga u zračenju/Heat output air	1.45kW
Minimalna toplotna snaga/Reduced heat output	8.30 kW
Snaga u radiatorima/Heat output water	7 kW
Snaga u zračenju/Heat output air	1.30 kW
Emisija CO/CO emission(at 13%O2)	Nominalna/Nominal 160 mg/Nm <sup>3</sup>
	Minimalna/Reduced 180 mg/Nm <sup>3</sup>
Stepen korisnosti/Efficiency	Nominalna/Nominal 93%
	Minimalna/Reduced 94%
Radni pritisak/Maximum water pressure	2.5 bar
Električni napon/ELECTRIC VOLTAGE	230 V
Frekvencija/FREQUENCY	50 Hz
Nominalna el. snaga/NOMINAL ELECTRICAL POWER	500 W



Minimalno rastojanje od zapaljivih materijala  
A=100cm,B=40cm,C=20cm/Minimal distance from combustible materials  
A=100cm,B=40cm,C=20cm

Gorivo/ FUEL C1  
Pridržavajte se uputstva/ Read and follow operating instructions  
Koristite samo preporučena goriva/ Use only recommended fuels  
U skladu sa standardom EN 14785:2006/ Complying with the norm EN 14785:2006



## 8.8 Manufactured



RADIJATOR Inženjering D.O.O.  
Živojina Lazi a Solunca br.6  
36000 Kraljevo, Srbija

## 9. Warranty

### 1. Co.”Radiator Engineering” covers different warranty periods for different parts ( as specified further on) only if the following conditions of guarantee are fulfilled:

- 1.1. Pellet boiler heating stove must be connected to the aforementioned hydraulic schemes of technical instruction , especially pay attention to the safety valves, thermal fuse swelling, mixing valve for protection of the cold portion of boiler or against condensation, the range of work pressure of boiler, r operating temperature of the boiler, the conditions in the boiler room, etc.(see item 3)
- 1.2. Pellet boiler heating stove must be connected to the chimney of prescribed cross-section, characteristics of insulation and height. (see item 3.4)
- 1.3. Flue gas outlet from boiler to the chimney must be constructed according to the technical instructions.
- 1.4. The said electrical connections must be done on the pellet boiler heating stove according to the technical instructions, particularly this refers to the characteristics of the room thermostat, the characteristics of the power supply, which must be within certain limits.
- 1.5. The user must follow the following instructions on how to use and maintain the boiler. (see item 8)

### 2. Warranty statement

We herewith declare:

- the product has the prescribed and declared quality properties . We are committed, we will, on the request of the buyer, if he timely submits the Request for the repair within the warranty period, do at any expense all repairs, so that the product will operate in accordance with the declared properties,
- that the product is will operate flawlessly within the warranty period if the instructions for the use, installation and operation are respected,
- that in the warranty period will be ready to remove all product failures and keep in stock all the necessary spare parts,
- **warranty period starts from the DATED OF PURCHASE AND LASTS FOR 60 or 72 MONTHS, from the date of manufacture ( the date of manufacture is located on the label on the back of the boiler ),**
- **60 MONTHS WARRANTY VALID ONLY IF THE BOILER service regularly by the central service “RADIJATOR INŽINJERING”, within the period specified for the same (in text below),**
- **warranty is valid if the warranty card is stamped by the Seller, with the registered date of purchase and the attached Sale Invoice/Bill. IT IS ALSO IMPORTANT TO HAVE THE ORDER FOR COMMISSIONING (certified by the Service).**



- 3. Warranty period of one year applies to the following parts:**
  - all bearings,
  - electric heaters firing.
- 4. Warranty period of two years applies to the following parts:**
  - fan,
  - boiler automation system with safety thermostat and other electric parts (pressure switch for water and pressure switch for flue gases),
  - probes for flue gases,
  - the probe for temperature of boiler water,
  - motor gearbox,
  - spirale in feeding system,
  - combustion chamber (combustion cap),
  - electrical connectors,
  - insulating materials on doors and openings for cleaning,
  - turbulators.
- 5. Warranty period does not apply:**
  - if after each heating season the regular servicing is not performed,
  - the replacement of parts in the regular annual maintenance in accordance with the instructions,
  - when failures are made by the purchaser due to improper handling of the product,
  - with mechanical failures made during transport and during use (solid objects),
  - if the product is installed improperly, contrary to the regulations in force in that area,
  - if the customer was using the product over the declared properties in normal circumstances.
  - on the glass door,
  - on the handle door.
- 6. Warranty period expires:**
  - if it is determined that the defects were removed by the unauthorized persons or unauthorized service,
  - if at repair the original parts were not built in,
  - when the warranty period expires.
- 7. When Reporting failures it is necessary to give the following information:**
  - name and type of product,
  - the date of purchase,
  - factory or workshop of the fireplace,
  - A brief description of the fault, or lack of,
  - full address of owner and contact telephone number, e-mail.

## 8. Regular annual service

Regular service is performed at the end of the heating season in the period from 15.4. to 31.8 and charged by the established price list of the Co. "Radiator Engineering". Service procedure by the technical persons performing regular annual service, which are authorized by the manufacturer for this, including the following operations:



**NOTE: The Service Provider is in obligation to inspect all of the following parts ( from the list ) feeder and exchanger, and if it comes to replacing of any parts of the same, the user receives the above-mentioned warranty and guarantee for another 12 months placed on the body of the boiler ( exchanger ). The warranty can be extended up to 5 years from the date of commissioning. Service and extension of service can be performed by a person sent by the Central Service of the Co. "Radiator engineering ". For not changed parts, after the servicing work, the service guarantee is not valid.**

- dismantling of pellet conveyor from the boiler, checking conveyor and checking bearings and lubricating;
- Bearing must not have difficulty in turning or cracks in the in the housing. Contrarily the bearing is replaced. If it is determined that the damage to the bearing is due to intrusion of solid objects into the pellet carrier (due to user's mistake or the manufacturer of pellet mistake), Co. "Radiator Engineering" shall charge value of the bearing. If the damage to the bearing is due to the withdrawal of the flame into the pellet transporter itself for reasons of poorly set parameters when using the boiler, Co. "Radiator Engineering" shall charge the value of the bearing.
- dismantling of combustion cup on combustion chamber and cleaning the space below combustion cap. Checking condition of combustion cap;
- checking and cleaning probe of flue gases;
- checking and cleaning fan;
- checking the sealing of door;
- check the maintenance of the boiler heat exchanger.
- Cleaning flue duct.

# GARANTNI LIST / GUARANTEE LIST

Tip kotla / Boiler type

Fabri ki broj / Factory No.

Garantni rok / Guarantee period

**60 MESECI/ 60 MONTHS**

Datum proizvodnje /  
Date of manufacture

Potpis ovlaš enog lica /  
Signature of Authorized person

pe at / stamp

Prodato u firmi / Company of Sale

Adresa / Address

Telefon / Phone

Datum prodaje / Date of Sale

Potpis / Signature

pe at / stamp

\*Potroša ina sva prava na osnovu Zakona o zaštiti potroša a ("Sl.glasnik RS", br. erbia62/2014). Garancija ne isklju uje niti uti e na prava potroša a koja proizilaze iz zakonske odgovornosti prodavca za nesaobczimost robe u ugovoru./ The consumer shall exercise all rights under the Consumer Protection Law ("OJ of RS" No 62/2014). The guarantee does not exclude nor affect the consumer's rights derived from the legal liability of the seller for any lack of conformity of the goods under a Contract.

\*Gore navedeno važi za kupce na prostoru Republike Srbije./ The aforementioned applies to purchasers of the Republic of Serbia.